



3/2, 5/2, 5/2 bistable and 5/3 way pneumatic solenoid valve

- Single or block mounting
- Suitable for outdoor and chemical atmospheres
- Suitable for low temperatures
- Explosion-proof versions
- Threaded or NAMUR flange connections

Type 6518/6519 can be combined with...



Type 2508
Cable plug



Type 2513
Cable plug
(ATEX Cat. 3 GD)



Type 2510/11
Cable plug ASI

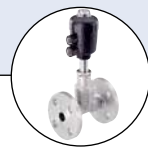

Type 2012
Single seat valve



Type 2030
Diaphragm valve

The Type 6518 is a servo-assisted 3/2 way valve and the Type 6519 is a 5/2 or 5/3 way valve. Together, they form a product line. The valves can be used individually or in blocks. The valves work without a continuous air consumption and are used for the pneumatic control of double or single-acting actuators. A solenoid valve Type 6014 is used as a pilot. The use of high quality materials makes it possible to use these valves in the open air and under chemical atmospheres. The product line contains units with Ex-Approvals and NAMUR flange interface.

Content 6518/6519

Page

6518/6519 Standard temperature range

6518/6519	Standard	2
	Ex m	3
	Ex i	4
6519 NAMUR	Standard	5
	Ex m	6
	Ex i	7
Manifold assembly with MP07 pneumatic modules		8
Accessories		10
Dimensions		12

6519 with extended temperature range

6519	Standard	20
	Ex m	22
	Ex i	24
6519 NAMUR	Standard	26
	Ex m	28
	Ex i	30
Accessories		32
Dimensions		34

Type 6518/6519 Standard (with tag connector acc.to DIN EN 175301-803 Form A, without cable plug)

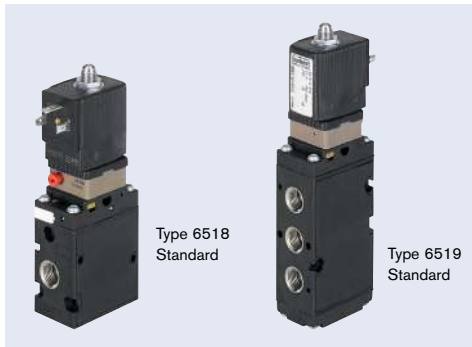

Type 6518 and the Type 6519 together form a product line. Both types can be mounted on a pneumatic module. The valve width of 32 mm allows high flow rates. A solenoid valve Type 6014 is used as a pilot. The valves can be used individually or in blocks.

Technical data		
Orifice	Type 6518 Type 6519	DN8 mm DN8 and 9 mm
Body material	Type 6518 Pilot and main valve Type 6519 Pilot valve Main valve	Polyamide, reinforced glass-fibre Polyamide, reinforced Polyamide (5/2 way), aluminium (5/3 way)
Threaded socket material		Brass (stainless steel on request)
Seal material	Type 6518 Type 6519	NBR and PUR NBR and PUR (5/2 way), NBR (5/3 way)
Medium		Neutral Medium, e.g. lubricated or non-lubricated compressed air
Compressed air quality		ISO 8573-1:2010, Class 7.4.4*
Medium temperature		-10 °C to +50 °C
Ambient temperature		-25 °C to +55 °C
Pneumatic connection	Supply port connection 1, 3, 5 Service port 2, 4	Thread G ¼, multi-station manifold (on request NPT ¼) Thread G ¼ (on request NPT ¼)
Operating voltages		24 V DC 24/ 110/ 230 V/ 50-60 Hz
Voltage tolerance		+10%
Duty cycle		100% continuous operation
Electrical connection		Tag connector acc. to DIN EN 175301-803 (previously DIN 43650) Form A for cable plug Type 2508
Type of protection		IP65 with cable plug
Installation		As required, preferably with actuator upright

* To prevent freezing of the expanded compressed air, the pressure dew point must be at least 10 K lower than the temperature of the medium.

Power consumption		
Inrush	Hold (hot coil)	
AC [VA]	AC [VA/W]	DC [W]
11	6/2	2

Response times ¹⁾	
Opening	20 [ms]
Closing	40 [ms]

¹⁾ Measured at valve outlet at 6 bar and +20 °C acc. to ISO 12238.
Opening: Pressure rise 0 to 90%,
Closing: Pressure drop 100 to 10%

Ordering chart with manual override (without manual override on request)

Circuit function	Orifice [mm]	Seal material and body	Threaded port connection [inch]	Q _{nv} value air ¹⁾ [l/min]	Pressure range ²⁾ [bar]	Weight [g]	Nominal power [W]	Voltage/Frequency [V/Hz]	Article no.
Type 6518 Standard – Brass threaded socket, also threads 1 and 3 of multi-station manifold; without cable plug									
C 3/2 way servo-controlled solenoid valve, normally closed, with manual override	8.0	NBR and PUR (Polyamide)	G ¼	1300	2-8	370	2	024/DC	132457
								024/50-60	132458
								110/50-60	132459
								230/50-60	132460
D 3/2 way servo-controlled, solenoid valve, normally open, with manual override	8.0	NBR and PUR (Polyamide)	G ¼	1300	2-8	370	2	024/DC	132461
								024/50-60	132462
								110/50-60	132463
								230/50-60	132464
Type 6519 Standard – Brass threaded socket, also threads 1, 3 and 5 of multi-station manifold; without cable plug									
H 5/2 way servo-controlled solenoid valve, with manual override	8.0	NBR and PUR (Polyamide)	G ¼	1300	2-8	450	2	024/DC	132465
								024/50-60	132466
								110/50-60	132467
								230/50-60	132468
L 5/3 way solenoid valve, in middle position all ports locked, with manual override	9.0	NBR (Aluminium)	G ¼	1300	3-10	720	2	024/DC	132469
								024/50-60	132470
								110/50-60	132471
								230/50-60	132472
N 5/3 way valve, in middle position ports 2 and 4 open, with manual override	9.0	NBR (Aluminium)	G ¼	1300	3-10	720	2	024/DC	132473
								024/50-60	132474
								110/50-60	132475
								230/50-60	132476

1) Flow rate: Q_{nv} value air [l/min]: Measured at +20 °C, 6 bar pressure at valve inlet and 1 bar pressure difference
2) Pressure values [bar]: Overpressure with respect to atmospheric pressure

Type 6518/6519 Ex m (with moulded cable, 3 m long, junction box on request)

The maximum fluid temperature may never exceed the permissible temperature class (T4 135 °C, T5 100 °C, T6 85 °C) minus 5K.



The approval Ex m is achieved by the mounting of an approved push-over coil. The cable connection and the cable are non-detachable and sealed together with the valve. The valves can be used individually or in blocks.

Response times ¹⁾	
Opening	20 [ms]
Closing	50 [ms]

¹⁾ Measured at valve outlet at 6 bar and +20 °C acc. to ISO 12238.
 Öffnen: Pressure rise 0 to 90%
 Closing: Pressure drop 100 to 10%

Technical data		
Orifice	Type 6518	DN8 mm
	Type 6519	DN8 and 9 mm
Body material	Type 6518 - Pilot & main valve	Polyamide, reinforced glass-fibre
	Type 6519 - Pilot valve	Polyamide, reinforced glass-fibre
	Main valve	Polyamide (5/2 way), aluminium (5/3 way)
Threaded socket material	Brass (stainless steel on request)	
Seal material	Type 6518	NBR and PUR
	Type 6519	NBR and PUR (5/2 way), NBR (5/3 way)
Medium	Neutral medium, e.g. lubricated or non-lubricated compressed air	
Compressed air quality	ISO 8573-1:2010, Class 7.4.4*	
Medium temperature	-10 °C to +50 °C	
Ambient temperature	-25 °C to +50 °C	
Pneumatic connection	Supply port connection 1, 3, 5	Thread G ¼, multi-station manifold (on request NPT ¼)
	Service port 2, 4	Thread G ¼ (on request NPT ¼)
Operating voltages	24/ 110/ 230 V/UC	
Voltage tolerance	+10%	
Duty cycle	100% continuous operation	
Electrical connection	3 m cable, moulded junction box (without fuse)	
Type of protection	IP65	
Approvals	Coil	PTB 14 ATEX 2023 X / IECEx PTB 14.0049 X II 2G Ex mb IIC T5 Gb II 2D Ex mb IIIC T 100 °C Db EPS16 ATEX 1046 X / IECEx EPS 16.0021 X II 2G EX eb mb IIC T5 Gb II 2D EX mb tb IIIC T100 °C Db
	Junction box	
Installation	As required, preferably with actuator upright	

* To prevent freezing of the expanded compressed air, the pressure dew point must be at least 10 K lower than the temperature of the medium.

Ordering chart with manual override (without manual override on request)

Circuit function	Orifice [mm]	Seal material and body	Threaded port connection [inch]	C _{Nr} value Luft ¹⁾ [l/min]	Pressure range ²⁾ [bar]	Weight [g]	Nominal power [W]	Voltage/Frequency [V/Hz]	Article no.
Type 6518 Ex m – Brass threaded socket, also threads 1 and 3 of multi-station manifold; with moulded cable, 3 m long³⁾									
C 3/2 way servo-controlled solenoid valve, normally closed, with manual override	8.0	NBR and PUR (Polyamide)	G ¼	1300	2-8	600	3	024/UC	278195
								110/UC	278200
								230/UC	278201
D 3/2 way servo-controlled, solenoid valve, normally open, with manual override	8.0	NBR and PUR (Polyamide)	G ¼	1300	2-8	600	3	024/UC	278205
								110/UC	x
								230/UC	x
Type 6519 Ex m – Brass threaded socket, also threads 1, 3 and 5 of multi-station manifold; with moulded cable, 3 m long⁴⁾									
H 5/2 way servo-controlled solenoid valve, with manual override	8.0	NBR and PUR (Polyamide)	G ¼	1300	2-8	700	3	024/UC	278209
								110/UC	278212
								230/UC	278213
L 5/3 way solenoid valve, in middle position all ports locked, with manual override	9.0	NBR (Aluminium)	G ¼	1300	3-10	1.100	3	024/UC	278221
								110/UC	x
								230/UC	x
N 5/3 way valve, in middle position ports 2 and 4 open, with manual override	9.0	NBR (Aluminium)	G ¼	1300	3-10	1.100	3	024/UC	278222
								110/UC	x
								230/UC	x

¹⁾ **Flow rate: Q_{Nr} value air [l/min]:** Measured at +20 °C, 6 bar pressure at valve inlet and 1 bar pressure difference
²⁾ **Pressure values [bar]:** Overpressure with respect to atmospheric pressure
³⁾ Versions with junction box on request
⁴⁾ Circuit function H (5/2 way) as impulse version on request
 x = on request

Type 6518/6519 Ex i (with Tag connector acc. to DIN EN 175301-803 Form A, without cable plug)

The maximum fluid temperature may never exceed the permissible temperature class (T4 135 °C, T5 100 °C, T6 85 °C) minus 5K.



The intrinsically-safe Type 6518 Ex i and 6519 Ex i valves consist of an intrinsically-safe pilot control and a pneumatic amplifier. The diaphragm-controlled valve seats work with very low friction, ensuring reliable switching of the valve, even after long shutdown periods.

Response times ¹⁾	
Opening	75 [ms]
Closing	115 [ms]

¹⁾ Measured at valve outlet at 6 bar and +20 °C acc. to ISO 12238.
 Opening: Pressure rise 0 to 90%
 Closing: Pressure drop 100 to 10%

Note

These units may only be used in explosive atmospheres in the manner approved by the Federal Institute of Physics and Technology (PTB), i.e., the permissible maximum electrical values must be complied with. Suitable barriers and isolating modules are available for this.

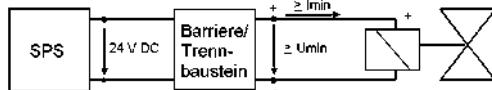

The valve is intended for operation on 24 V DC outputs via the intermediate switching of a corresponding intrinsically-safe operating resource (isolating module or barrier).
 If required, request the "Recommended Barrier and Isolating Module" data sheet.

Technical data		
Orifice	Type 6518	DN8 mm
	Type 6519	DN8 and 9 mm
Body material	Pilot valve	Stainless steel 1.4305 or brass
	Main valve	Polyamide, reinforced glass-fibre
Threaded socket material	Brass (stainless steel on request)	
Seal material	FPM, NBR and PUR	
Medium	Neutral medium, e.g. lubricated or non-lubricated compressed air	
Compressed air quality	ISO 8573-1:2010, Class 7.4.4*	
Medium temperature	-10 °C to +50 °C	
Ambient temperature	-25 °C to +55 °C	
Pneumatic connection	Supply port connection 1, 3, 5	Thread G ¼, multi-station manifold (on request PT1/4)
	Service port 2, 4	Thread G ¼ (on request NPT ¼)
Duty cycle	100% continuous operation	
Electrical connection	Tag connector acc. to DIN EN 175301-803 (previously DIN 43650) Form A for cable plug Type 2508 (not in delivery, see accessories), check for correct polarity	
Type of protection	IP65 with cable plug	
Installation	As required, preferably with actuator upright	

* To prevent freezing of the expanded compressed air, the pressure dew point must be at least 10 K lower than the temperature of the medium.

Electrical data - Coil AC10 Ex i

Approvals	PTB 01 ATEX 2101 / PTB IECEx10.0019 II 2G Ex ia IIC T6 Gb II 2G Ex ia IIC T80 °C Db		
Function values for Switching function valve¹⁾	at +20 °C	at +55 °C	
	Minimum switching current	29 mA	29 mA
	Nominal resistance coil	310 Ω	360 Ω
Minimum terminal voltage	9.0 V	10.4 V	
Conformity specifications	U _i 35 V I _i 0.9 A P _i 1.1 W		

¹⁾ With high resistance coil on request

Ordering chart for valves without manual override (with manual override and high resistance coil on request)

Circuit function	Orifice [mm]	Seal material and body	Threaded port connection [inch]	Q _{nn} value Luft ¹⁾ [l/min]	Pressure range ²⁾ [bar]	Weight [g]	Body material pilot valve	Material air control connector	Article no.
Type 6518 Ex i without cable plug									
<p>3/2 way servo-controlled solenoid valve, normally closed</p>	8.0	NBR and PUR (Polyamide)	G ¼	1300	2-8	580	St. St. 1.4305	St. St.	145111
							Brass	Brass, nickel plated	144486
							Brass	Brass, nickel plated	147253
Type 6519 Ex i without cable plug									
<p>5/2 way servo-controlled solenoid valve</p>	8.0	NBR and PUR (Polyamide)	G ¼	1300	2-8	670	St. St. 1.4305	St. St.	144484
							Brass	Brass, nickel plated	144485
							Brass	Brass, nickel plated	147252

¹⁾ Flow rate: Q_{nn} value air [l/min]: Measured at +20 °C, 6 bar pressure at valve inlet and 1 bar pressure difference

²⁾ Pressure values [bar]: Overpressure with respect to atmospheric pressure

Type 6519 NAMUR Standard (with Tag connector acc. to DIN EN 175301-803 Form A, without cable plug)



Type 6519 NAMUR Standard

The valve bodies of Type 6519 NAMUR are identical with the Ex m variants. The difference is in the coils, which are laid out and approved in different ways. By changing the coil on the valve body, it is possible to easily convert from Non-Ex operation to Ex operation (or vice versa). The coils are designed to be push-over and can be locked in $4 \times 90^\circ$ displaced positions and be positioned anywhere in-between.

Technical data	
Orifice	Type 6519 DN6 mm
Body material	Type 6519 Pilot and main valve Polyamide, reinforced glass-fibre
Threaded socket material	Brass (stainless steel on request)
Seal material	Type 6519 NBR and PUR
Medium	Neutral medium, e.g. lubricated or non-lubricated compressed air
Compressed air quality	ISO 8573-1:2010, Class 7.4.4*
Medium temperature	-10 °C to +50 °C
Ambient temperature	-25 °C to +55 °C
Pneumatic connection	Supply port connection 1, 3, 5 Thread G ¼, (on request NPT ¼) Service port 2, 4 NAMUR Flange
Operating voltages	24 V DC 24/ 110/ 230 V/ 50-60 Hz
Voltage tolerance	+10%
Duty cycle	100 % continuous operation
Electrical connection	Tag connector acc. to DIN EN 175301-803 (previously DIN 43650) Form A for cable plug Type 2508
Type of protection	IP65 with cable plug
Installation	As required, preferably with actuator upright

* To prevent freezing of the expanded compressed air, the pressure dew point must be at least 10 K lower than the temperature of the medium.

Power consumption			Response times ¹⁾	
Inrush AC [VA]	Hold (hot coil) AC [VA/W]	DC [W]	Opening	Closing
11	6/2	2	20 [ms]	40 [ms]

¹⁾ Measured at valve outlet at 6 bar and +20 °C acc. to ISO 12238.
Opening: Pressure rise 0 to 90%,
Closing: Pressure drop 100 to 10%

Ordering chart with manual override (without manual override on request)

Circuit function	Orifice [mm]	Seal material and body	Material sockets ¹⁾	Threaded port connection [inch]	$Q_{n, \text{air}}$ value Luft ²⁾ [l/min]	Pressure range ³⁾ [bar]	Weight [g]	Electrical nominal power [W]	Voltage/Frequency [V/Hz]	Article no.
W 	6.0	NBR and PUR	Stainless steel	G ¼	900	2-8	460	2	024/DC	131425
									024/50-60	131426
									110/50-60	131427
									230/50-60	131428
W 	6.0	NBR and PUR	Brass, nickel plated	G ¼	900	2-8	460	2	024/DC	131421
									024/50-60	131422
									110/50-60	131423
									230/50-60	131424

¹⁾ When the connecting sockets are made of stainless steel, then the mounting screws are also made of stainless steel

²⁾ Flow rate: $Q_{n, \text{air}}$ value air [l/min]: Measured at +20 °C, 6 bar pressure at valve inlet and 1 bar pressure difference

³⁾ Pressure values [bar]: Overpressure with respect to atmospheric pressure

All valves can be operated in circuit function C as well as in circuit function H. By replacing the adapter plate that comes with the valves, the change between the two circuit functions can be set up.

Type 6519 NAMUR Ex m (with moulded cable) or Ex me (with junction box)

The maximum fluid temperature may never exceed the permissible temperature class (T4 135 °C, T5 100 °C, T6 85 °C) minus 5K.



Type 6519 NAMUR Ex m

The valve made out of premium polyamide can be operated either as a 5/2 or a 3/2 way version through different mounting plates. The solenoid valve Type 6014 with a coil approved for use in hazardous areas is connected as a pilot. The NAMUR flange interface allows easy assembly on different pneumatic actuators on the spot.

The valve bodies are identical with the Type 6519 NAMUR standard version. The difference between the valves is in the coils, which are laid out and approved in different ways. By changing the coil on the valve body, it is possible to easily convert from Non-Ex operation to Ex operation (or vice versa). Coil versions with moulded cable are designed to be push-over and can be locked in 4 × 90° displaced positions and be positioned any where in-between.

Technical data	
Orifice	DN6 mm
Body material	Pilot and main valve Polyamide, reinforced glass-fibre
Threaded socket material	Brass (stainless steel on request)
Seal material	NBR and PUR
Medium	Neutral medium, e.g. lubricated or non-lubricated compressed air
Compressed air quality	ISO 8573-1:2010, Class 7.4.4*
Medium temperature	-10 °C to +50 °C
Ambient temperature	-25 °C to +50 °C
Pneumatic connection	Supply port connection 1, 3, 5 Service port 2, 4 Thread G ¼, (on request NPT ¼) NAMUR Flange
Operating voltages	24/ 110/ 230 V/UC
Voltage tolerance	+10 %
Duty cycle	100% continuous operation
Electrical connection	3 m cable, moulded junction box (without fuse)
Type of protection	IP65
Approvals	Coil PTB 14 ATEX 2023 X / IECEx PTB 14.0049 X II 2G Ex mb IIC T5 Gb II 2D Ex mb IIIC T 100 °C Db EPS16 ATEX 1046 X / IECEx EPS 16.0021 X II 2G EX eb mb IIC T5 Gb II 2D EX mb tb IIIC T100 °C Db
Installation	As required, preferably with actuator upright

* To prevent freezing of the expanded compressed air, the pressure dew point must be at least 10 K lower than the temperature of the medium.

Response times ¹⁾	
Opening	20 [ms]
Closing	40 [ms]

¹⁾ Measured at valve outlet at 6 bar and +20 °C acc. to ISO 12238.

Opening: Pressure rise 0 to 90%,
Closing: Pressure drop 100 to 10 %

Ordering chart with manual override (without manual override on request)

Circuit function	Orifice [mm]	Seal material and body	Material sockets ¹⁾	Threaded port connection [inch]	Q _v value Luft ²⁾ [l/min]	Pressure range ³⁾ [bar]	Weight [g]	Electrical Nominal power [W]	Voltage/Frequency [V/Hz]	Article no.	
W 	Version acc. to Ex m, with moulded 3 m-cable										
	6.0	NBR and PUR	Stainless steel	G ¼	900	2-8	650	3	024/UC	278231	
									110/UC	278234	
									230/UC	278237	
	or	6.0	NBR and PUR	Brass, nickel plated	G ¼	900	2-8	650	3	024/UC	278228
										110/UC	278235
230/UC										278239	
W 	Version acc. to Ex me, with junction box without fuse										
	6.0	NBR and PUR	Stainless steel	G ¼	900	2-8	690	3	024/UC	289407	
									230/UC	289415	
									024/UC	289406	
	5/2 or 3/2 way solenoid valve, with removable disk and manual override	6.0	NBR and PUR	Brass, nickel plated	G ¼	900	2-8	690	3	110/UC	289412
										230/UC	289414

¹⁾ When the connecting sockets are made of stainless steel, then the mounting screws are also made of stainless steel

²⁾ Flow rate: Q_v value air [l/min]: Measured at +20 °C, 6 bar pressure at valve inlet and 1 bar pressure difference

³⁾ Pressure values [bar]: Overpressure with respect to atmospheric pressure

All valves can be operated in circuit function C as well as in circuit function H. By replacing the adapter plate that comes with the valves, the change between the two circuit functions can be set up.

Type 6519 NAMUR Ex i (with Tag connector acc. to DIN EN 175301-803 Form A, without cable plug)

The maximum fluid temperature may never exceed the permissible temperature class (T4 135 °C, T5 100 °C, T6 85 °C) minus 5K.



Type 6519 NAMUR Ex i

The Type 6519 NAMUR Ex i valve is used for the pneumatic control of double or single-acting actuators with a NAMUR adapter plate flange. The circuit function can easily be changed using an adapter plate. In the 3/2 way function, feedback of the exhaust air takes place in the spring area of the armature drive. The diaphragm-controlled valve seats work with very low friction, ensuring reliable switching of the valve even after long shutdown periods and at ambient temperatures below 0 °C. The valves work without a continuous air consumption.

Note

The units may only be used in explosive atmospheres in the manner approved by the Federal Institute of Physics and Technology (PTB), i.e., the permissible maximum electrical values must be complied with. Suitable barriers and isolating modules are available for this.

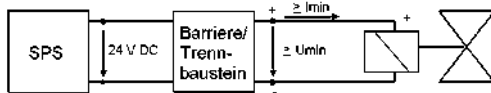

The valve is intended for operation on 24 V DC outputs via the intermediate switching of a corresponding intrinsically-safe operating resource (isolating module or barrier). If required, request the "Recommended Barrier and Isolating Module" data sheet.

Technical data	
Orifice	DN6 mm
Body material	Pilot valve: Stainless steel 1.4305 or brass Main valve: Polyamide, reinforced glass-fibre
Threaded socket material	Brass (stainless steel on request)
Seal material	FPM, NBR and PUR
Medium	Neutral medium, e.g. lubricated or non-lubricated compressed air
Compressed air quality	ISO 8573-1:2010, Class 7.4.4*
Medium temperature	-10 °C to +50 °C
Ambient temperature	-25 °C to +55 °C
Pneumatic connection	Supply port connection 1, 3, 5: Thread G 1/4, (on request NPT 1/4) Service port 2, 4: NAMUR Flange
Duty cycle	100% continuous operation
Electrical connection	Tag connector acc. to DIN EN 175301-803 (previously DIN 43650) Form A for cable plug Type 2508 (not in delivery, see accessories), check for correct polarity
Type of protection	IP65 with cable plug
Installation	As required, preferably with actuator upright

* To prevent freezing of the expanded compressed air, the pressure dew point must be at least 10 K lower than the temperature of the medium.

Response times ¹⁾	[ms]	¹⁾ Measured at valve outlet at 6 bar and +20 °C acc. to ISO 12238.
Opening	75	Opening: Pressure rise 0 to 90%
Closing	115	Closing: Pressure drop 100 to 10%

Electrical data		
Approvals	PTB 01 ATEX 2101 / PTB IECEx10.0019 II 2G Ex ia IIC T6 Gb II 2G Ex ia IIIC T80 °C Db	
Function values for Switching function valve¹⁾	at +20 °C	at +55 °C
Minimum switching current	29 mA	29 mA
Nominal resistance coil	310 Ω	360 Ω
Minimum terminal voltage	9.0 V	10.4 V
Conformity specifications	U _i : 35 V I _i : 0.9 A P _i : 1.1 W	

¹⁾ With high resistance coil on request

Ordering chart for valves without manual override (with manual override and high resistance coil on request)

without cable plug

Circuit function	Orifice [mm]	Seal material and body	Threaded port connection [inch]	Q ₉₀ value Luft ¹⁾ [l/min]	Pressure range ²⁾ [bar]	Weight [g]	Body material pilot valve	Material air control connector	Article no.
<p>W</p>	6.0	NBR and PUR (Polyamide)	G 1/4	900	2-8	670	St. St. 1.4305	St. St.	144482 ☒
or							Brass, nickel plated	144483 ☒	
W							Brass	Brass, nickel plated	147244 ☒

1) Flow rate: Q₉₀ value air [l/min]: Measured at +20 °C, 6 bar pressure at valve inlet and 1 bar pressure difference
2) Pressure values [bar]: Overpressure with respect to atmospheric pressure

All valves can be operated in circuit function C as well as in circuit function H. By replacing the adapter plate that comes with the valves, the change between the two circuit functions can be set up. All valves have mounting plates and tag connectors acc. to DIN EN 175301-803 Form A (previously DIN 43650) and are supplied without cable plug

Pneumatic modules Type MP07

Single modules or pre-mounted blocks are available.

Example of a complete valve block

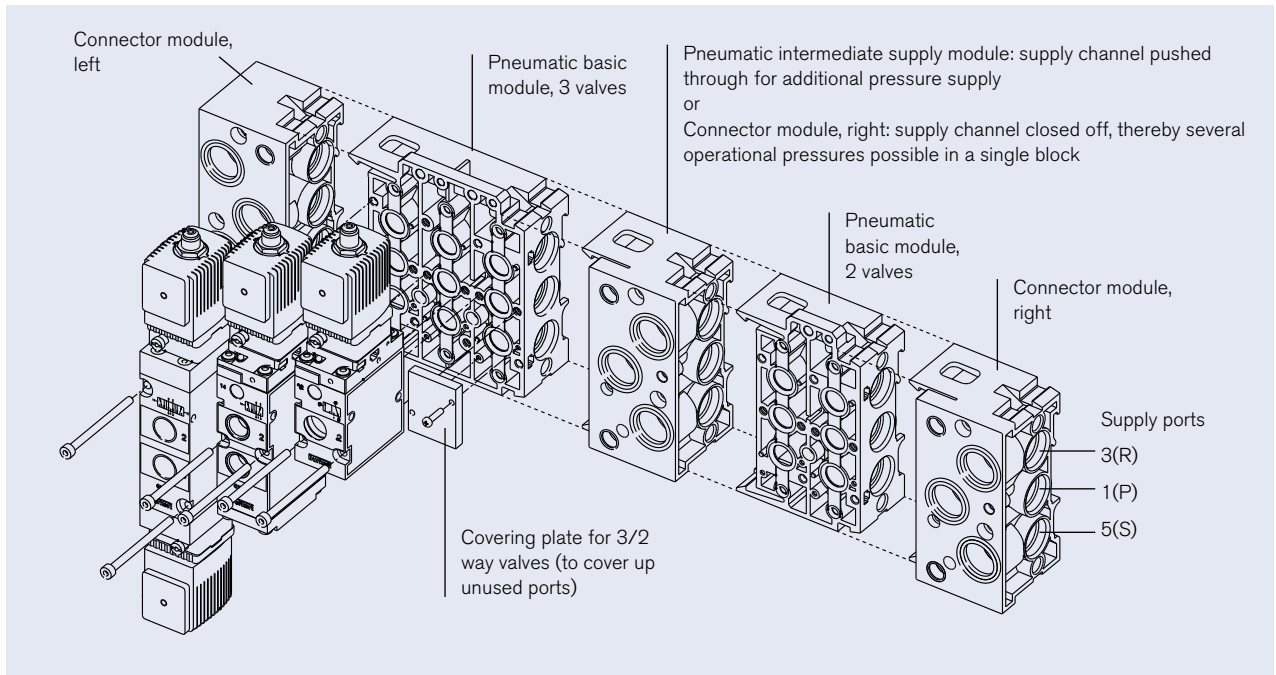

Note when ordering complete valve blocks:

Please list the modules in the block assembly from right to left, as shown in the ordering example. Valves with NAMUR Flange. Ex i coil or Ex versions with junction boxes are not suitable for block mounting.

Ordering example for Type 6518 with Type MP07

No.	Unit	Article no.
1	Connector module right, G ½	635331
1	Pneumatic basic module, 2 valves	635319
1	Pneumatic basic module, 3 valves	635343
1	Connector module left, G ½	635324
5	Valves	132457

Ordering chart for Type MP07 pneumatic modules

Version	Article no.
Connector module right G ½	635331
Intermediate supply module	637505
Pneumatic basic module, 2 valves universal (for 3/2-, 5/2- and 5/3 way)	635319
Pneumatic basic module, 3 valves universal (for 3/2-, 5/2- and 5/3 way)	635343
Connector module left G ½	635324
Covering plate for 5/2- and 5/3 way (to cover unused valve positions)	635335
Covering plate for 3/2 way (to cover unused connections)	635337

Accessories

Cable plug 2508 acc. to DIN EN 175301-803 Form A

The delivery of a cable plug includes the flat seal and the fixing screw. For other cable plug versions acc. to DIN EN 175301-803 Form A (previously DIN 43650) with integrated circuitry, see datasheet Type 2508.

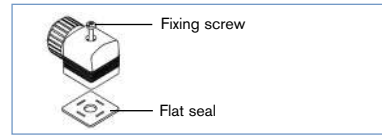

Dimensions Type 2508 [mm]

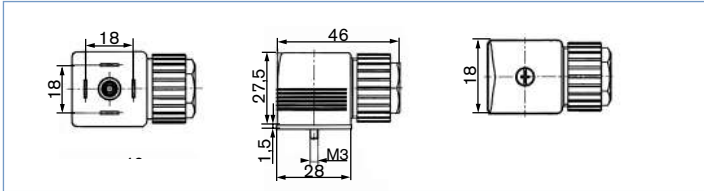

Ordering chart

Cable plug 2508

Beschaltung	Voltage	Article no.
For standard version 6518/19		
Fixing screw in steel (galvanised and chrome-plated)		
without circuitry	0-250 V	008376
with LED	12-24 V	008360
with LED and varistor	12-24 V	008367
with LED and varistor	200-240 V	008369
For Ex i version 6519		
Fixing screw in stainless steel 1.4404 and blue compression gland nut		
without circuitry	0-250 V	438574
for further versions see datasheet 2508		

Cable plug Type 2513 acc. to DIN EN 175301-803, Form A

Meets the requirements of ATEX category 3 GD

		Cable length [mm]	Article no. [in mm]
		12000	260893
		5000	260892
		3000	260891
		300	260890

Ordering chart for further accessories

Accessories	Features	Article no.
Cap nut	Cap nut in stainless steel for additional protection of the exhaust air channel from the penetration of damp	649554
Blanking plug	G 1/8"	780141
	G 1/4"	780142
	G 1/2"	780144
Silencer	G 1/8"	005305
	G 1/4"	005064
	G 1/2"	005062
Labelling plate	64 pieces	635416





Semi-delay fuse for 6519 NAMUR Ex m

Voltage [V]	Max. current [mA]	Article no.
24 V	315 mA	153733
110 V	50 mA	153716
230 V	32 mA	153715

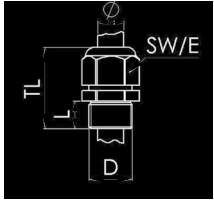

Accessories (continued)

Ex-Cable glands

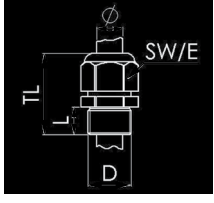
(polyamide version included in delivery / surcharge applied for brass nickel plated version)

Photo	Description	Ex Approvals		Article no	Drawing										
		Certification	Identifica-tion												
	Brass, nickel-plated, 6-13 mm	PTB 04 ATEX 1112 X, IECEx PTB 13.0027X	II 2 G Ex e IIC Gb, II 2 D Ex tb IIIC Db IP68,	773278 	 <table border="1"> <tr><td>TL</td><td>29-37 mm</td></tr> <tr><td>L</td><td>6 mm</td></tr> <tr><td>D</td><td>20</td></tr> <tr><td>SW</td><td>24 mm</td></tr> <tr><td>E</td><td>27 mm</td></tr> </table>	TL	29-37 mm	L	6 mm	D	20	SW	24 mm	E	27 mm
TL	29-37 mm														
L	6 mm														
D	20														
SW	24 mm														
E	27 mm														
	Polyamide, 7-13 mm	PTB 13 ATEX 1015 X, IECEx PTB 13.0034X	II 2 G Ex e IIC Gb, II 2 D Ex tb IIIC Db IP68	773277 	 <table border="1"> <tr><td>TL</td><td>36-45 mm</td></tr> <tr><td>L</td><td>10 mm</td></tr> <tr><td>D</td><td>20</td></tr> <tr><td>SW</td><td>24 mm</td></tr> <tr><td>E</td><td>28 mm</td></tr> </table>	TL	36-45 mm	L	10 mm	D	20	SW	24 mm	E	28 mm
TL	36-45 mm														
L	10 mm														
D	20														
SW	24 mm														
E	28 mm														

Special tool to turn the junction box (not included in delivery)

Photo	Description	Article no.
	Set SC02-AC10 Special wrench Service Manual	293488 

Dimensions [mm]

Standard versions

Type 6518
3/2 way valve, circuit function C and D

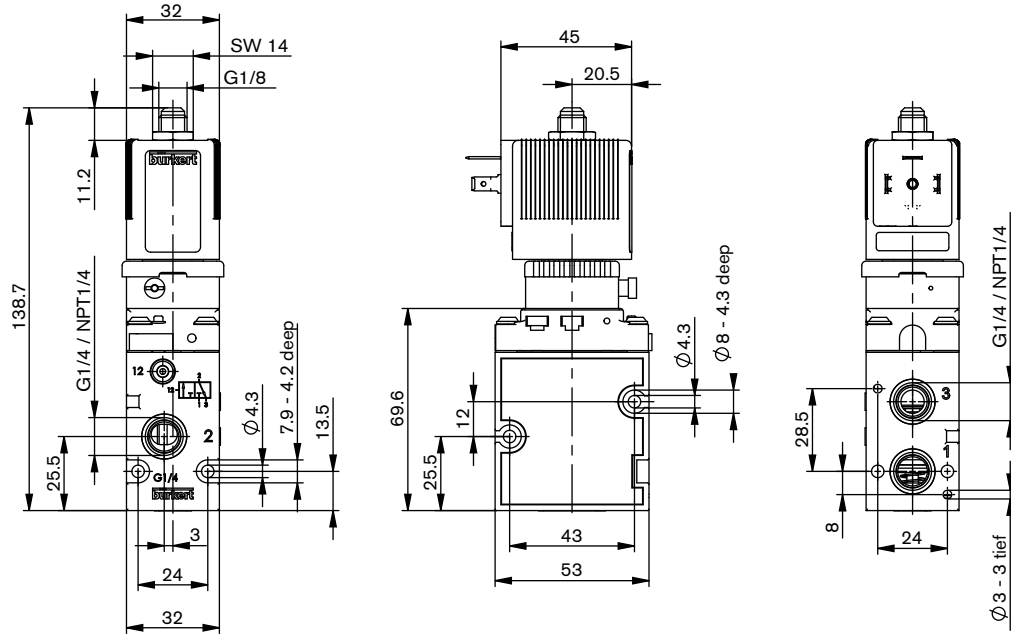

Type 6519
5/2 way valve, circuit function H

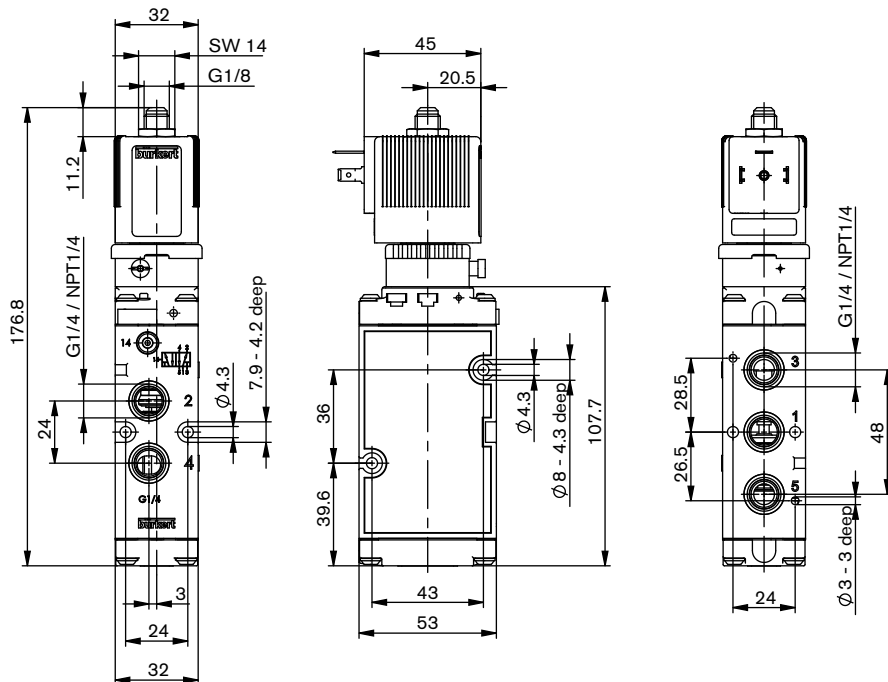

* Mounting length with 2 magnetic coils 249 mm

Dimensions [mm]

Standard versions

Type 6519
5/3 way valve, circuit function L and N

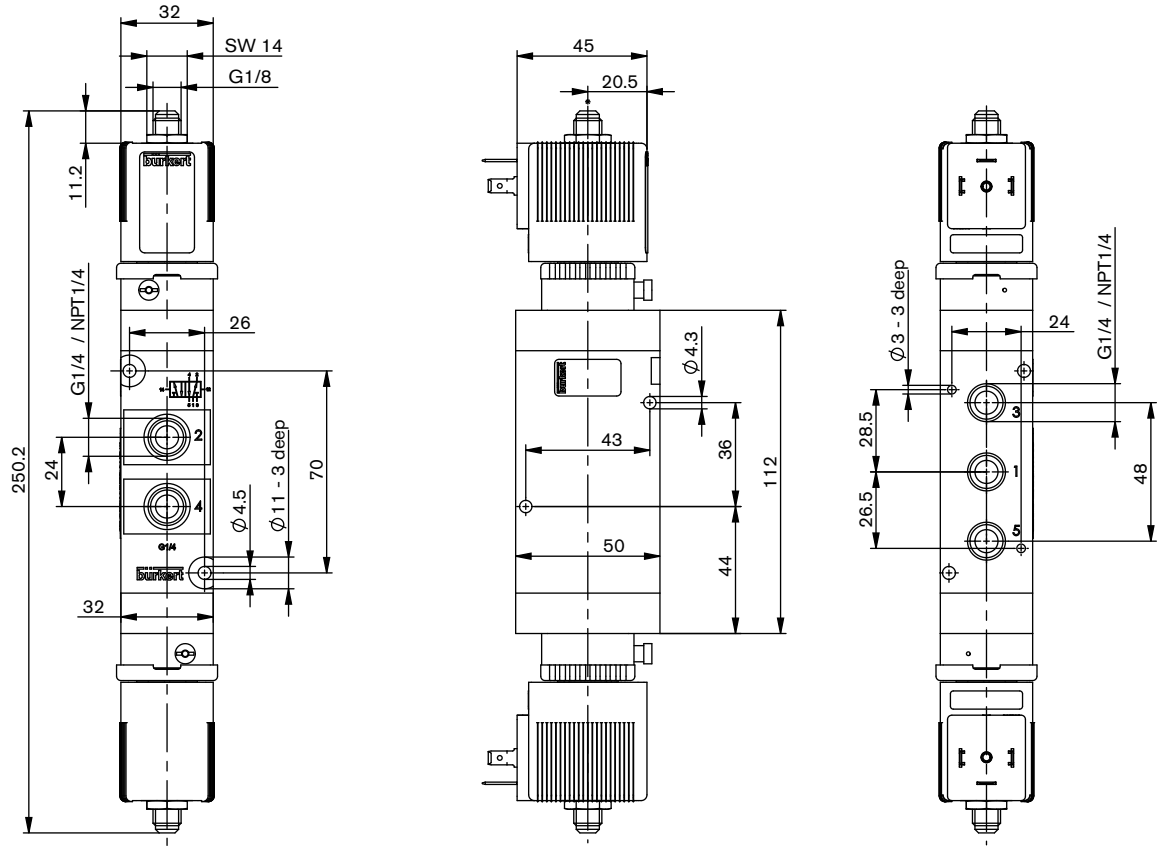

Dimensions [mm]

Ex m/me versions

Type 6519

5/2 way valve, circuit function H

with moulded cable (3 m long) (Ex m)

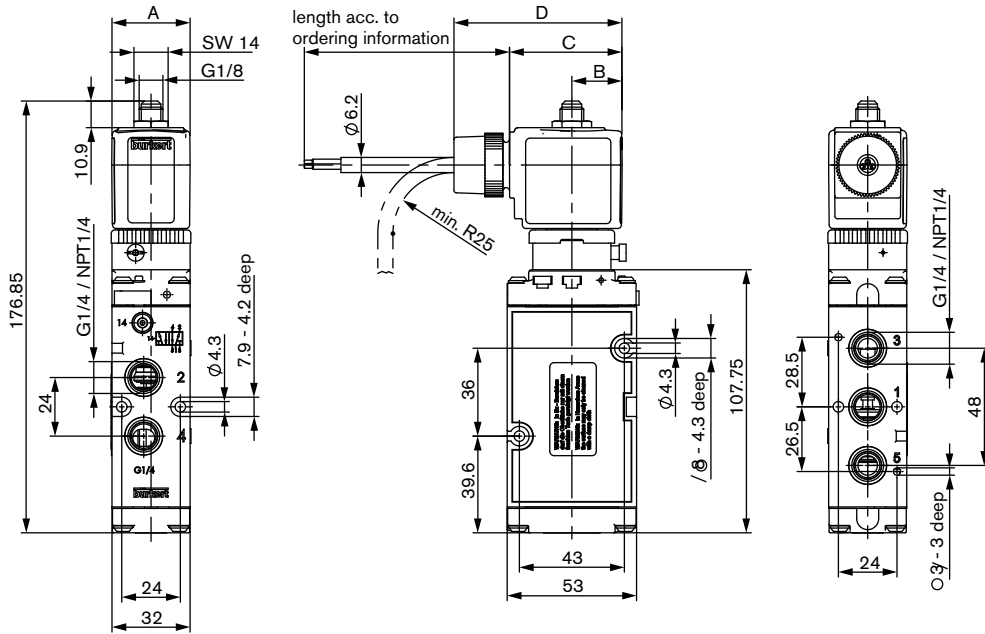

5/2 way valve, circuit function L and N

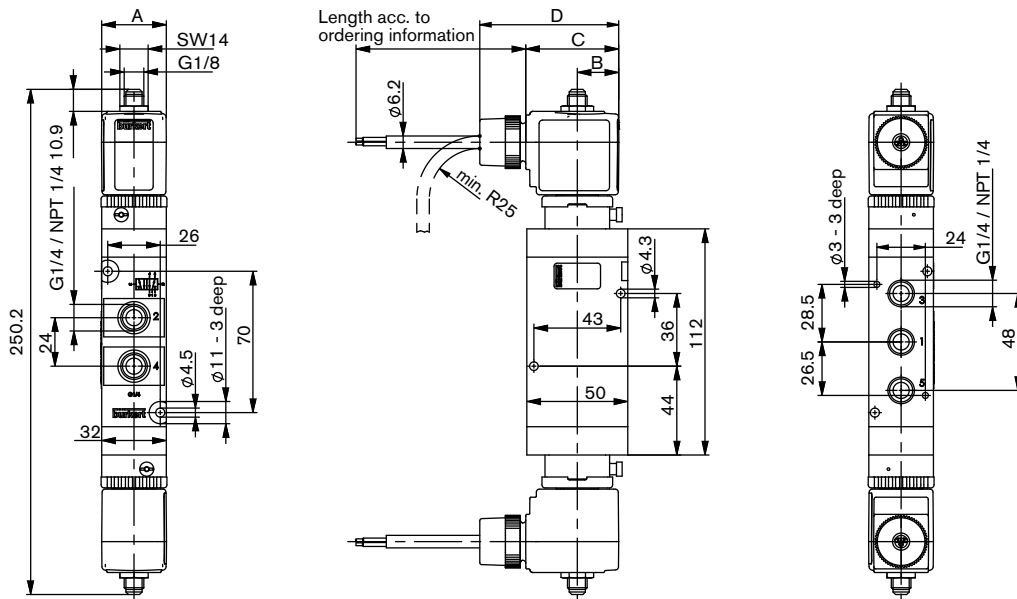

Dimensions [mm]

NAMUR Standard version

Type 6519

3/2 way valve, circuit function C or 5/2 way valve, circuit function H

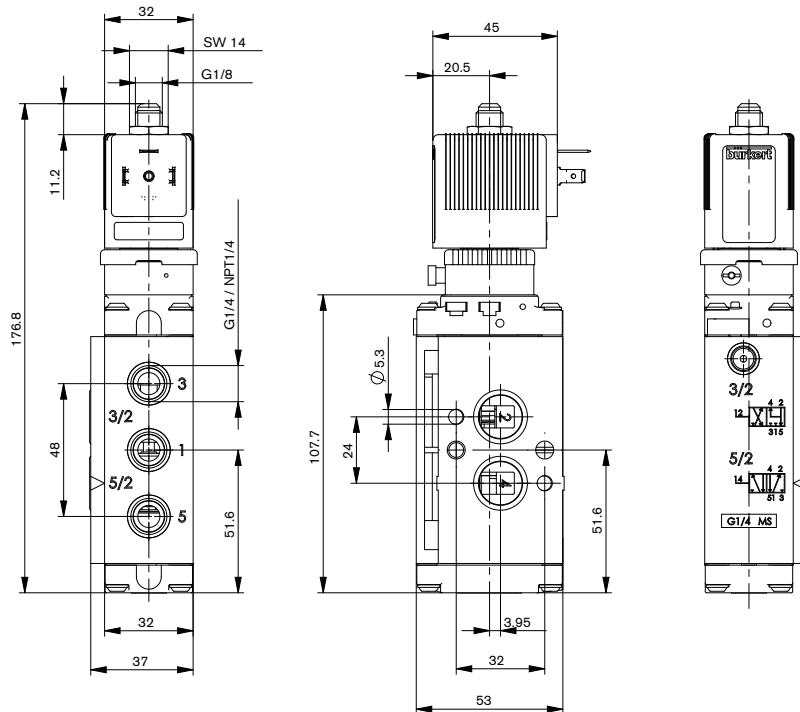

Dimensions [mm]

NAMUR Ex i version

Type 6519
 3/2 way valve, circuit function C or 5/2 way valve, circuit function H

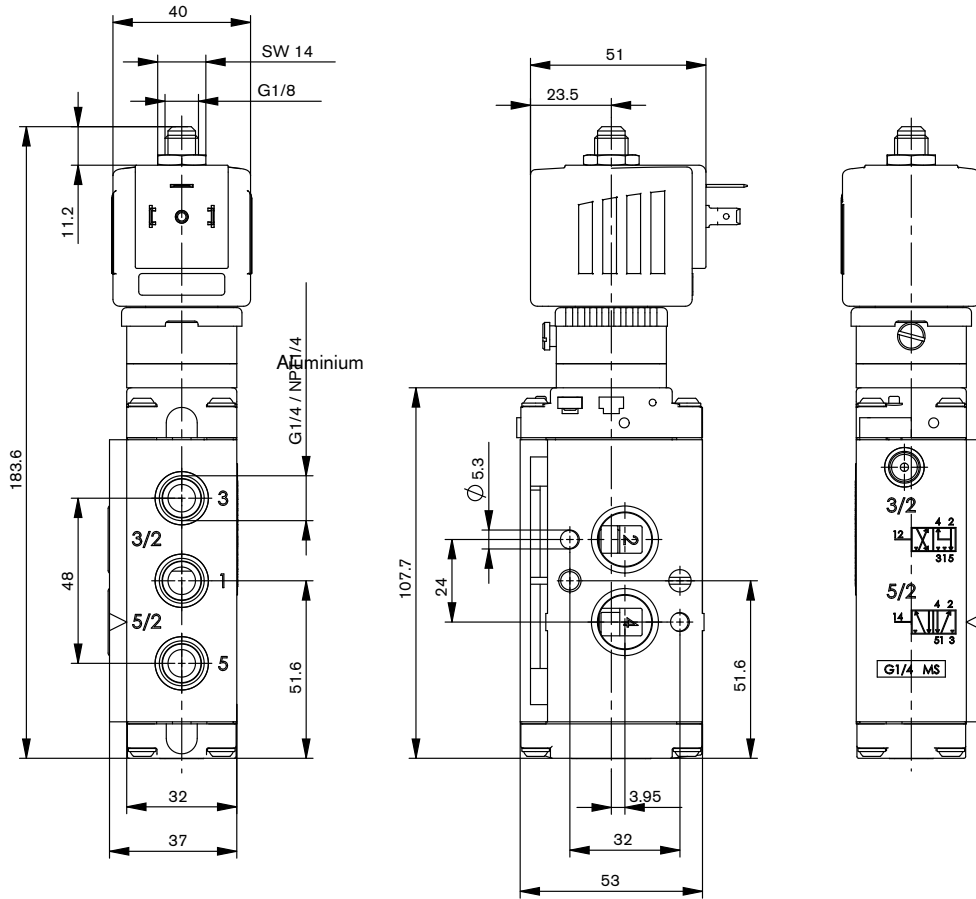

6519
for extended
temperature range

Type 6519 for extended standard temperature range



Technical data	Aluminium	Stainless steel				
Orifice	9	9				
Body material						
Pilot valve	Stainless steel	Stainless steel				
Main valve	Aluminium ematal coated	Stainless steel 1.4571				
Threaded socket material	in aluminium	in stainless steel				
Seal material	FPM, NBR	PU, NBR, FPM				
Medium	Neutral medium, eg lubricated or non-lubricated compressed air					
Compressed air quality	ISO 8573-1:2010, Class 7.2.4*					
Medium temperature	-30 °C to +80 °C	-30 °C to +80 °C				
Ambient temperature	-40 °C to +80 °C	-30 °C to +80 °C				
Pneumatic connection	Supply port connection 1, 3, 5 Thread G ¼, (on request NPT ¼) Service port 2, 4 Thread G ¼ (on request NPT ¼)					
Operating voltages	24 V DC 24/ 110/ 230 V/ 50-60 Hz					
Voltage tolerance	+10%					
Electr. power consumption	2 W					
Duty cycle	100% continuous operation					
Electrical connection	Tag connector acc. to DIN EN 175301-803 (previously DIN 43650) Form A for cable plug Type 2508					
Type of protection	IP65 with cable plug					
Installation	As required, preferably with actuator upright					
Response times	5/2	5/2-bi	5/3	3/2	5/2	5/2-bi
Opening [ms]	16	18	16	13	12	14
Closing [ms]	27	18	22	47	74	14

* To prevent freezing of the expanded compressed air, the pressure dew point must be at least 10 K lower than the temperature of the medium.

Ordering chart for valves in aluminium with manual override (without manual override on request)



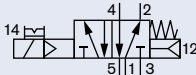
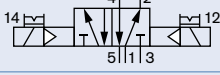
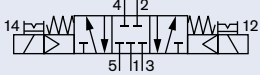
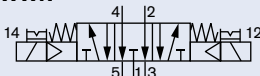







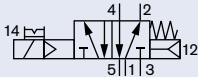



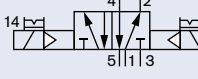

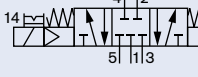

All products come with a standard stainless steel cap nut. This cap nut protects the exhaust channel from penetrating humidity.

Circuit function	Orifice [mm]	Seal material and body	Threaded port connection [inch]	Q _{NO} -value air [l/min]	Pressure range [bar]	Weight [g]	Nominal power [W]	Voltage/Frequency [V/Hz]	Article no.
 5/2 WWH	9.0	FPM, NBR	G ¼"	1800	2.5-10	680	2	024/DC	231386
								024/50-60	231387
								110/50-60	231388
								230/50-60	231389
 5/2-bistable WWZ	9.0	FPM, NBR	G ¼"	2100	2.5-10	990	2	024/DC	231390
								024/50-60	231391
								110/50-60	231392
230/50-60	231393								
 5/3 WWL	9.0	FPM, NBR	G ¼"	1500	2.5-10	1060	2	024/DC	231394
								024/50-60	231395
								110/50-60	231396
230/50-60	231397								
 5/3 WWN	9.0	FPM, NBR	G ¼"	1500	2.5-10	1060	2	024/DC	231399
								024/50-60	231400
								110/50-60	231401
230/50-60	231402								

6519
for extended
temperature range

Ordering chart for valves in stainless steel with manual override (without manual override on request)

All products come with a standard stainless steel cap nut. This cap nut protects the exhaust channel from penetrating humidity.

Circuit function	Orifice [mm]	Seal material body	Threaded port connection [inch]	C_{N_2} -value air [l/min]	Pressure range [bar]	Weight [g]	Nominal power [W]	Voltage/Frequency [V/Hz]	Article no.
5/2 WWH 	8.0	PU, NBR	G 1/4"	1980	3-10	1370	2	024/DC	231403 
								024/50-60	231404 
								110/50-60	231405 
								230/50-60	231406 
5/2-bistable WWZ 	8.0	PU, NBR	G 1/4"	1920	3-10	1680	2	024/DC	231407 
								024/50-60	231408 
								110/50-60	231409 
								230/50-60	231410 
5/3 WWL 	8.0	PU, NBR	G 1/4"	1770	3-10	1680	2	024/DC	231411 
								024/50-60	231412 
								110/50-60	231413 
								230/50-60	231414 
5/3 WWN 	8.0	PU, NBR	G 1/4"	1770	3-10	1680	2	024/DC	231415 
								024/50-60	231416 
								110/50-60	231417 
								230/50-60	231418 

6519
for extended
temperature range



Type 6519 for extended Ex m temperature range

The maximum fluid temperature may never exceed the permissible temperature class (T4 135 °C, T5 100 °C, T6 85 °C) minus 5K.



Technical data	Aluminium	Stainless steel				
Orifice	9	9				
Body material						
Pilot valve	Stainless steel	Stainless steel				
Main valve	Aluminium ematal coated	Stainless steel 1.4571				
Threaded socket material	in aluminium	in stainless steel				
Seal material	FPM, NBR	PU, NBR, FPM				
Medium	Neutral medium, e.g. lubricated or non-lubricated compressed air					
Compressed air quality	ISO 8573-1:2010, Class 7.2.4*					
Medium temperature	-30 °C to +80 °C	-30 °C to +80 °C				
Ambient temperature	-40 °C to +60 °C	-30 °C to +60 °C				
Pneumatic connection	Supply port connection 1, 3, 5 Service port 2, 4					
	Thread G ¼, (on request NPT ¼) Thread G ¼ (on request NPT ¼)					
Operating voltages	24 V DC 24/ 110/ 230 V/ 50-60 Hz					
Voltage tolerance	+10%					
Electr. power consumption	3 W					
Duty cycle	100% continuous operation					
Electrical connection	3 m cable, moulded junction box (without fuse) on request					
Type of protection	IP65					
Approvals						
Coil	PTB 14 ATEX 2023 X / IECEx PTB 14.0049 X II 2G Ex mb IIC T5 Gb II 2D Ex mb IIIC T 100 °C Db					
Junction box	EPS16 ATEX 1046 X / IECEx EPS 16.0021 X II 2G EX eb mb IIC T5 Gb II 2D EX mb tb IIIC T100 °C Db					
Installation	As required, preferably with actuator upright					
Response times	5/2	5/2-bi	5/3	3/2	5/2	5/2-bi
Opening [ms]	16	18	16	13	12	14
Closing [ms]	27	18	22	47	74	14

* To prevent freezing of the expanded compressed air, the pressure dew point must be at least 10 K lower than the temperature of the medium.

Ordering chart for valves in aluminium with manual override (without manual override on request)

All products come with a standard stainless steel cap nut. This cap nut protects the exhaust channel from penetrating humidity.

Circuit function	Orifice [mm]	Seal material body	Threaded port connection [inch]	Q_{Nn} -value air [l/min]	Pressure range [bar]	Weight [g]	Nominal power [W]	Voltage/Frequency [V/Hz]	Article no.
Type 6519 Ex m - with moulded cable, 3 m long¹⁾									
5/2 WWH 	9.0	FPM, NBR	G ¼"	1800	2.5-10	680	3	024/UC	278217
								110/UC	x
								230/UC	278220
5/2-bistable WWZ 	9.0	FPM, NBR	G ¼"	2100	2.5-10	990	3	024/UC	278247
								110/UC	x
								230/UC	x
5/3 WWL 	9.0	FPM, NBR	G ¼"	1500	2.5-10	1060	3	024/UC	x
								110/UC	x
								230/UC	x
5/3 WWN 	9.0	FPM, NBR	G ¼"	1500	2.5-10	1060	3	024/UC	278223
								110/UC	x
								230/UC	x





¹⁾ Junction box version on request

x = on request

6519
for extended
temperature range

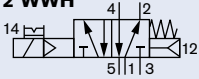
Ordering chart for valves in stainless steel with manual override (without manual override on request)

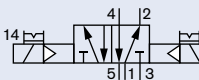
All products come with a standard stainless steel cap nut. This cap nut protects the exhaust channel from penetrating humidity.

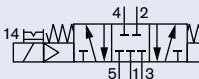
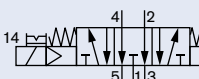
Circuit function	Orifice [mm]	Seal material body	Threaded port connection [inch]	C_{N_2} -value air [l/min]	Pressure range [bar]	Weight [g]	Nominal power [W]	Voltage/Frequency [V/Hz]	Article no.
Type 6519 Ex m - with moulded cable, 3 m long¹⁾									
5/2 WWH 	8.0	PU, NBR	G 1/4"	1980	3-10	1370	3	024/UC	x
								110/UC	x
								230/UC	278219 
5/2-bistable WWZ 	8.0	PU, NBR	G 1/4"	1920	3-10	1680	3	024/UC	278246 
								110/UC	x
								230/UC	x
5/3 WWL 	8.0	PU, NBR	G 1/4"	1770	3-10	1680	3	024/UC	x
								110/UC	x
								230/UC	x
5/3 WWN 	8.0	PU, NBR	G 1/4"	1770	3-10	1680	3	024/UC	x
								110/UC	x
								230/UC	x

¹⁾ Junction box version on request

x = on request

6519
for extended
temperature range

bürkert

Type 6519 for extended Ex i temperature range

The maximum fluid temperature may never exceed the permissible temperature class (T4 135 °C, T5 100 °C, T6 85 °C) minus 5K.



Technical data	Aluminium	Stainless steel
Orifice Type 6519	9	9
Body material		
Pilot valve	Stainless steel	Stainless steel
Main valve	Aluminium ematal coated	Stainless steel 1.4571
Threaded socket material	in aluminium	in stainless steel
Seal material	FPM, NBR	PU, NBR, FPM
Medium	Neutral medium, e.g. lubricated or non-lubricated compressed air	
Compressed air quality	ISO 8573-1:2010, Class 7.2.4*	
Medium temperature	-30 °C to +80 °C	-30 °C to +80 °C
Ambient temperature	-40 °C to +75 °C	-30 °C to +75 °C
Pneumatic connection		
Supply port connection 1, 3, 5	Thread G ¼, (on request NPT ¼)	
Service port 2, 4	Thread G ¼ (on request NPT ¼)	
Voltage tolerance	+10%	
Electrical connection	Tag connector acc. to DIN EN 175301-803 (previously DIN 43650) Form A for cable plug Type 2508 (not in delivery, see accessories), check for correct polarity	
Type of protection	IP65 with cable plug	
Installation	As required, preferably with actuator upright	

Response times	5/2	5/2-bi	5/3	3/2	5/2	5/2-bi
Opening [ms]	16	18	16	13	12	14
Closing [ms]	27	18	22	47	74	14

* To prevent freezing of the expanded compressed air, the pressure dew point must be at least 10 K lower than the temperature of the medium.

Electrical data - coil AC10 Ex i		
Approvals	PTB 01 ATEX 2101 / PTB IECEx10.0019 II 2G Ex ia IIC T6 Gb II 2G Ex ia IIIC T80 °C Db	
Function values for Switching function valve¹⁾	at +20 °C	at +55 °C
Minimum switching current	29 mA	29 mA
Nominal resistance coil	310 Ω	360 Ω
Minimum terminal voltage	9.0 V	10.4 V
Conformity specifications		
U _i	35 V	
I _i	0.9 A	
P _i	1.1 W	

¹⁾ With high resistance coil on request

Note

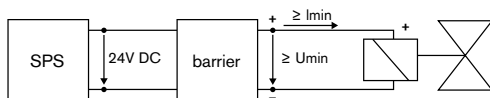







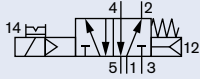

These units may only be used in explosive atmospheres in the manner approved by the Federal Institute of Physics and Technology (PTB), i.e., the permissible maximum electrical values must be complied with. Suitable barriers and isolating modules are available for this.

The valve is intended for operation on 24 V DC outputs via the intermediate switching of a corresponding intrinsically-safe operating resource (isolating module or barrier).

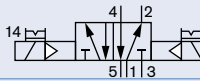
6519
for extended
temperature range

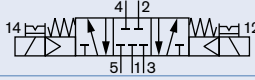

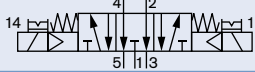



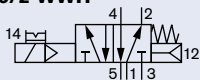

Ordering chart for valves in aluminium with manual override (without manual override on request)

All products come with a standard stainless steel cap nut. This cap nut protects the exhaust channel from penetrating humidity.

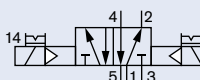
Circuit function	Orifice [mm]	Seal material body	Threaded port connection [inch]	Q ₉₀ -value air [l/min]	Pressure range [bar]	Weight [g]	Minimum switching current [mA]	Nominal resistance coil [Ohm]	Minimum terminal voltage [V]	Article no.
5/2 WWH 	9.0	FPM, NBR	G 1/4"	1800	2.5-10	825	29	310	9	231452 
							23	481	11	231453 
5/2-bistable WWZ 	9.0	FPM, NBR	G 1/4"	2100	2.5-10	1280	29	310	9	231454 
							23	481	11	231455 
5/3 WWL 	9.0	FPM, NBR	G 1/4"	1500	2.5-10	1350	29	310	9	231456 
							23	481	11	231457 
5/3 WWN 	9.0	FPM, NBR	G 1/4"	1500	2.5-10	1350	29	310	9	231458 
							23	481	11	231459 

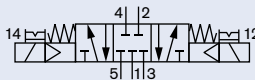
Ordering chart for valves in stainless steel with manual override (without manual override on request)

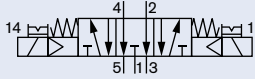
All products come with a standard stainless steel cap nut. This cap nut protects the exhaust channel from penetrating humidity.

Circuit function	Orifice [mm]	Seal material body	Threaded port connection [inch]	Q ₉₀ -value air [l/min]	Pressure range [bar]	Weight [g]	Minimum switching current [mA]	Nominal resistance coil [Ohm]	Minimum terminal voltage [V]	Article no.
5/2 WWH 	8.0	PU, NBR	G 1/4"	1980	3-10	1520	29	310	9	231460 
							23	481	11	231461 
5/2-bistable WWZ 	8.0	PU, NBR	G 1/4"	1920	3-10	1970	29	310	9	231463 
							23	481	11	231464 
5/3 WWL 	8.0	PU, NBR	G 1/4"	1770	3-10	1970	29	310	9	231465 
							23	481	11	231466 
5/3 WWN 	8.0	PU, NBR	G 1/4"	1770	3-10	1970	29	310	9	231467 
							23	481	11	231468 

6519
for extended
temperature range

Type 6519 for extended NAMUR standard temperature range



Technical data	Aluminium	Stainless steel				
Orifice	6	6				
Body material						
Pilot valve	Stainless steel	Stainless steel				
Main valve	Aluminium ematal coated	Stainless steel 1.4571				
Threaded socket material	in aluminium	in stainless steel				
Seal material	FPM, NBR	PU, NBR, FPM				
Medium	Neutral medium, e.g. lubricated or non-lubricated compressed air					
Compressed air quality	ISO 8573-1:2010, Class 7.2.4*					
Medium temperature	-30 °C to +80 °C	-30 °C to +80 °C				
Ambient temperature	-40 °C to +80 °C	-30 °C to +80 °C				
Pneumatic connection	Supply port connection 1, 3, 5 Service port 2, 4					
Operating voltages	24 V DC 24/ 110/ 230 V/ 50-60 Hz					
Voltage tolerance	+10 %					
Electr. power consumption	2 W					
Duty cycle	100 % continuous operation					
Electrical connection	Tag connector acc. to DIN EN 175301-803 (previously DIN 43650) Form A for cable plug Type 2508					
Type of protection	IP65 with cable plug					
Installation	As required, preferably with actuator upright					
Response times	5/2	5/2-bi	5/3	3/2	5/2	5/2-bi
Opening [ms]	16	18	16	13	12	14
Closing [ms]	27	18	22	47	74	14

* To prevent freezing of the expanded compressed air, the pressure dew point must be at least 10 K lower than the temperature of the medium.

Ordering chart for valves in aluminium with manual override (without manual override on request)

All products come with a standard stainless steel cap nut. This cap nut protects the exhaust channel from penetrating humidity.

Circuit function	Orifice [mm]	Seal material body	Threaded port connection [inch]	Q _{in} -value air [l/min]	Pressure range [bar]	Weight [g]	Nominal power [W]	Voltage/Frequency [V/Hz]	Article no.
3/2 WWC 	6.0	FPM, NBR	G 1/4"	780	3-10	540	2	024/DC	231469
								024/50-60	231470
								110/50-60	231471
								230/50-60	231472
5/2 WWH 	6.0	FPM, NBR	G 1/4"	800	3-10	540	2	024/DC	231473
								024/50-60	231474
								110/50-60	231475
								230/50-60	231476
5/2-bistable WWZ 	6.0	FPM, NBR	G 1/4"	900	3-10	540	2	024/DC	231477
								024/50-60	231478
								110/50-60	231479
								230/50-60	231480

6519
for extended
temperature range

Ordering chart for valves in stainless steel with manual override (without manual override on request)

All products come with a standard stainless steel cap nut. This cap nut protects the exhaust channel from penetrating humidity.

Circuit function	Orifice [mm]	Seal material body	Threaded port connection [inch]	Q_{N_2} -value air [l/min]	Pressure range [bar]	Weight [g]	Nominal power [W]	Voltage/Frequency [V/Hz]	Article no.
3/2 WWC 	6.0	PU, NBR	G 1/4"	1280	3-10	540	2	024/DC	231481
								024/50-60	231482
								110/50-60	231483
								230/50-60	231484
5/2 WWH 	6.0	PU, NBR	G 1/4"	1060	3-10	540	2	024/DC	231485
								024/50-60	231486
								110/50-60	231487
								230/50-60	231488
5/2-bistable WWZ 	6.0	PU, NBR	G 1/4"	1050	3-10	540	2	024/DC	231489
								024/50-60	231490
								110/50-60	231491
								230/50-60	231492

6519
for extended
temperature range



Type 6519 for extended NAMUR Ex m temperature range

The maximum fluid temperature may never exceed the permissible temperature class (T4 135 °C, T5 100 °C, T6 85 °C) minus 5K.



Technical data	Aluminium	Stainless steel				
Orifice	6	6				
Body material						
Pilot valve	Stainless steel	Stainless steel				
Main valve	Aluminium ematal coated	Stainless steel 1.4571				
Threaded socket material	in aluminium	in stainless steel				
Seal material	FPM, NBR	PU, NBR, FPM				
Medium	Neutral medium, e.g. lubricated or non-lubricated compressed air					
Compressed air quality	ISO 8573-1:2010, Class 7.2.4*					
Medium temperature	-30 °C to +80 °C	-30 °C to +80 °C				
Ambient temperature	-40 °C to +60 °C	-30 °C to +60 °C				
Pneumatic connection	Thread G ¼, (on request NPT ¼) NAMUR Flange					
Supply port connection 1, 3, 5						
Service port 2, 4						
Operating voltages	24 V DC 24/ 110/ 230 V/ 50-60 Hz					
Voltage tolerance	+10%					
Electr. power consumption	3 W					
Duty cycle	100% continuous operation					
Electrical connection	3 m cable, moulded junction box (without fuse) on request					
Type of protection	IP65					
Approvals						
Coil	PTB 14 ATEX 2023 X / IECEx PTB 14.0049 X II 2G Ex mb IIC T5 Gb II 2D Ex mb IIIC T 100 °C Db					
Junction box	EPS16 ATEX 1046 X / IECEx EPS 16.0021 X II 2G EX eb mb IIC T5 Gb II 2D EX mb tb IIIC T100 °C Db					
Installation	As required, preferably with actuator upright					
Response times	5/2	5/2-bi	5/3	3/2	5/2	5/2-bi
Opening [ms]	16	18	16	13	12	14
Closing [ms]	27	18	22	47	74	14

* To prevent freezing of the expanded compressed air, the pressure dew point must be at least 10 K lower than the temperature of the medium.

Ordering chart for valves in aluminium with manual override (without manual override on request)

All products come with a standard stainless steel cap nut. This cap nut protects the exhaust channel from penetrating humidity.

Circuit function	Orifice [mm]	Seal material body	Threaded port connection [inch]	Q _N -value air [l/min]	Pressure range [bar]	Weight [g]	Nominal power [W]	Voltage/Frequency [V/Hz]	Article no.
Type 6519 Ex m - with moulded cable, 3 m long¹⁾									
3/2 WWC 	6.0	FPM, NBR	G ¼"	780	3-10	540	3	024/UC	x
								110/UC	x
								230/UC	x
5/2 WWH 	6.0	FPM, NBR	G ¼"	800	3-10	540	3	024/UC	278207
								110/UC	x
								230/UC	x
5/2-bistable WWZ 	6.0	FPM, NBR	G ¼"	900	3-10	540	3	024/UC	278242
								110/UC	x
								230/UC	x

¹⁾ Junction box version on request

x = on request

6519
for extended
temperature range

Ordering chart for valves in stainless steel with manual override (without manual override on request)

All products come with a standard stainless steel cap nut. This cap nut protects the exhaust channel from penetrating humidity.

Circuit function	Orifice [mm]	Seal material body	Threaded port connection [inch]	Q_{N_2} -value air [l/min]	Pressure range [bar]	Weight [g]	Nominal power [W]	Voltage/Frequency [V/Hz]	Article no.
Type 6519 Ex m - with moulded cable, 3 m long¹⁾									
3/2 WWC 	6.0	PU, NBR	G 1/4"	1280	3-10	960	3	024/UC	x
								110/UC	x
								230/UC	x
5/2 WWH 	6.0	PU, NBR	G 1/4"	1060	3-10	960	3	024/UC	x
								110/UC	x
								230/UC	x
5/2-bistable WWZ 	6.0	PU, NBR	G 1/4"	1050	3-10	1260	3	024/UC	x
								110/UC	x
								230/UC	x

¹⁾ Junction box version on request

x = on request

6519
for extended
temperature range

Type 6519 for extended NAMUR Ex i temperature range

The maximum fluid temperature may never exceed the permissible temperature class (T4 135 °C, T5 100 °C, T6 85 °C) minus 5K.



Technical data	Aluminium	Stainless steel				
Orifice Type 6519	6	6				
Body material						
Pilot valve	Stainless steel	Stainless steel				
Main valve	Aluminium ematal coated	Stainless steel 1.4571				
Threaded socket material	in aluminium	in stainless steel				
Seal material	FPM, NBR	PU, NBR, FPM				
Medium	Neutral medium, e.g. lubricated or non-lubricated compressed air					
Compressed air quality	ISO 8573-1:2010, Class 7.2.4*					
Medium temperature	-30 °C to +80 °C	-30 °C to +80 °C				
Ambient temperature	-40 °C to +75 °C	-30 °C to +75 °C				
Pneumatic connection	Supply port connection 1, 3, 5 Service port 2, 4					
	Thread G ¼, (on request NPT ¼) NAMUR Flange					
Voltage tolerance	+10%					
Electrical connection	Tag connector acc. to DIN EN 175301-803 (previously DIN 43650) Form A for cable plug Type 2508 (not in delivery, see accessories), check for correct polarity					
Type of protection	IP65 with cable plug					
Installation	As required, preferably with actuator upright					
Response times	5/2	5/2-bi	5/3	3/2	5/2	5/2-bi
Opening [ms]	16	18	16	13	12	14
Closing [ms]	27	18	22	47	74	14

* To prevent freezing of the expanded compressed air, the pressure dew point must be at least 10 K lower than the temperature of the medium.

Electrical data - coil AC10 Ex i		
Approvals	PTB 01 ATEX 2101 / PTB IECEx10.0019 II 2G Ex ia IIC T6 Gb II 2G Ex ia IIIC T80 °C Db	
Function values for Switching function valve*	at +20 °C	at +55 °C
Minimum switching current	29 mA	29 mA
Nominal resistance coil	310 Ohm	360 Ohm
Minimum terminal voltage	9.0 V	10.4 V
Conformity specifications		
U _i	35 V	
I _i	0.9 A	
P _i	1.1 W	

Note

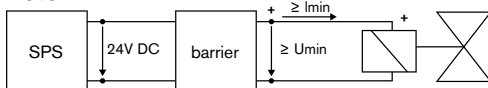

These units may only be used in explosive atmospheres in the manner approved by the Federal Institute of Physics and Technology (PTB), i.e., the permissible maximum electrical values must be complied with. Suitable barriers and isolating modules are available for this.

The valve is intended for operation on 24 V DC outputs via the intermediate switching of a corresponding intrinsically-safe operating resource (isolating module or barrier).

6519
for extended
temperature range

Ordering chart for valves in aluminium with manual override (without manual override on request)

All products come with a standard stainless steel cap nut. This cap nut protects the exhaust channel from penetrating humidity.

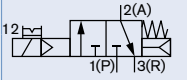
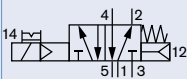
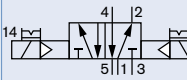
Circuit function	Orifice [mm]	Seal material body	Threaded port connection [inch]	Q_{N_2} -value air [l/min]	Pressure range [bar]	Weight [g]	Minimum switching current [mA]	Nominal resistance coil [Ohm]	Minimum terminal voltage[V]	Article no.
 <p>3/2 WWC</p>	6.0	FPM, NBR	G 1/4"	780	3-10	690	29	310	9	231520
							23	481	11	231521
 <p>5/2 WWH</p>	6.0	FPM, NBR	G 1/4"	800	3-10	690	29	310	9	231522
							23	481	11	231523
 <p>5/2 bistable WWZ</p>	6.0	FPM, NBR	G 1/4"	900	3-10	1140	29	310	9	231524
							23	481	11	231525

Ordering chart for valves in stainless steel with manual override (without manual override on request)

All products come with a standard stainless steel cap nut. This cap nut protects the exhaust channel from penetrating humidity.

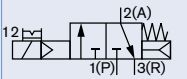
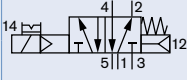
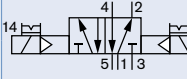
Circuit function	Orifice [mm]	Seal material body	Threaded port connection [inch]	Q_{N_2} -value air [l/min]	Pressure range [bar]	Weight [g]	Minimum switching current [mA]	Nominal resistance coil [Ohm]	Minimum terminal voltage[V]	Article no.
 <p>3/2 WWC</p>	6.0	PU, NBR	G 1/4"	1280	3-10	1100	29	310	9	231526
							23	481	11	231527
 <p>5/2 WWH</p>	6.0	PU, NBR	G 1/4"	1060	3-10	1100	29	310	9	231528
							23	481	11	231529
 <p>5/2 bistable WWZ</p>	6.0	PU, NBR	G 1/4"	1050	3-10	1550	29	310	9	231530
							23	481	11	231531

6519
for extended
temperature range

Accessories

Cable plug 2508 acc. to DIN EN 175301-803 Form A

Included in delivery is a connector with flat seal and fixing screw.

For other cable plug versions acc. to DIN EN 175301-803 Form A (previously DIN 43650) with integrated circuitry, see datasheet Type 2508.

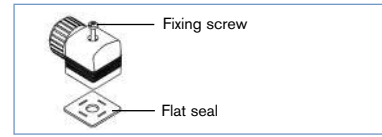

Dimensions Type 2508 [mm]

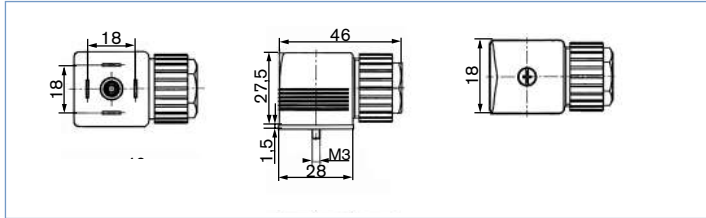

Ordering chart for cable plug 2508

Circuit	Voltage	Article no.
For standard version 6519 fixing screw in steel (galvanised and chrome-plated)		
without circuitry	0-250 V	008376
with LED	12-24 V	008360
with LED and varistor	12-24 V	008367
with LED and varistor	200-240 V	008369
For Ex i version 6519		
Fixing screw in stainless steel 1.4404 and blue compression gland nut		
without circuitry	0-250 V	438574
for further versions see datasheet 2508		

Cable plug Type 2513 acc. to DIN EN 175301-803, Form A

Meets the requirements of ATEX category 3 GD

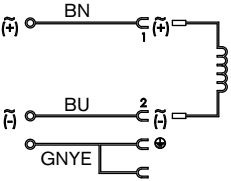
 	Cable length [mm]	Article no. [in mm]
	12000	260893
	5000	260892
	3000	260891
	300	260890

Ordering chart for further accessories

Accessories	Features	Article no.
Cap nut 	Cap nut in stainless steel for additional protection of the exhaust channel from penetrating humidity,	649554
Blanking plug	G ¼	780142
Silencer	G ¼	005064
Labelling plate	64 pieces	635416

Semi-delay fuse for 6519 NAMUR Ex m





Voltage [V]	Max. current [mA]	Article no.
24 V	315 mA	153733
110 V	50 mA	153716
230 V	32 mA	153715

6519
for extended
temperature range

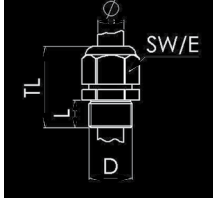

Accessories (continued)

Ex-Cable glands

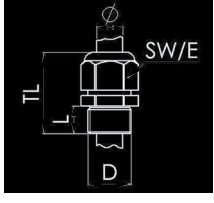
(polyamide version included in delivery / surcharge applied for brass nickel plated version)

Photo	Description	Ex Approvals		Article no	Drawing										
		Certification	Identifica- tion												
	Brass, nickel-plated, 6-13 mm	PTB 04 ATEX 1112 X, IECEx PTB 13.0027X	II 2 G Ex e IIC Gb, II 2 D Ex tb IIIC Db IP68,	773278 	 <table border="1"> <tr><td>TL</td><td>29-37 mm</td></tr> <tr><td>L</td><td>6 mm</td></tr> <tr><td>D</td><td>20</td></tr> <tr><td>SW</td><td>24 mm</td></tr> <tr><td>E</td><td>27 mm</td></tr> </table>	TL	29-37 mm	L	6 mm	D	20	SW	24 mm	E	27 mm
TL	29-37 mm														
L	6 mm														
D	20														
SW	24 mm														
E	27 mm														
	Polyamide, 7-13 mm	PTB 13 ATEX 1015 X, IECEx PTB 13.0034X	II 2 G Ex e IIC Gb, II 2 D Ex tb IIIC Db IP68	773277 	 <table border="1"> <tr><td>TL</td><td>36-45 mm</td></tr> <tr><td>L</td><td>10 mm</td></tr> <tr><td>D</td><td>20</td></tr> <tr><td>SW</td><td>24 mm</td></tr> <tr><td>E</td><td>28 mm</td></tr> </table>	TL	36-45 mm	L	10 mm	D	20	SW	24 mm	E	28 mm
TL	36-45 mm														
L	10 mm														
D	20														
SW	24 mm														
E	28 mm														

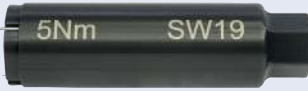
Special tool to turn the junction box (not included in delivery)

Photo	Description	Article no.
	Set SC02-AC10 Special wrench Service Manual	293488 

Dimensions [mm]

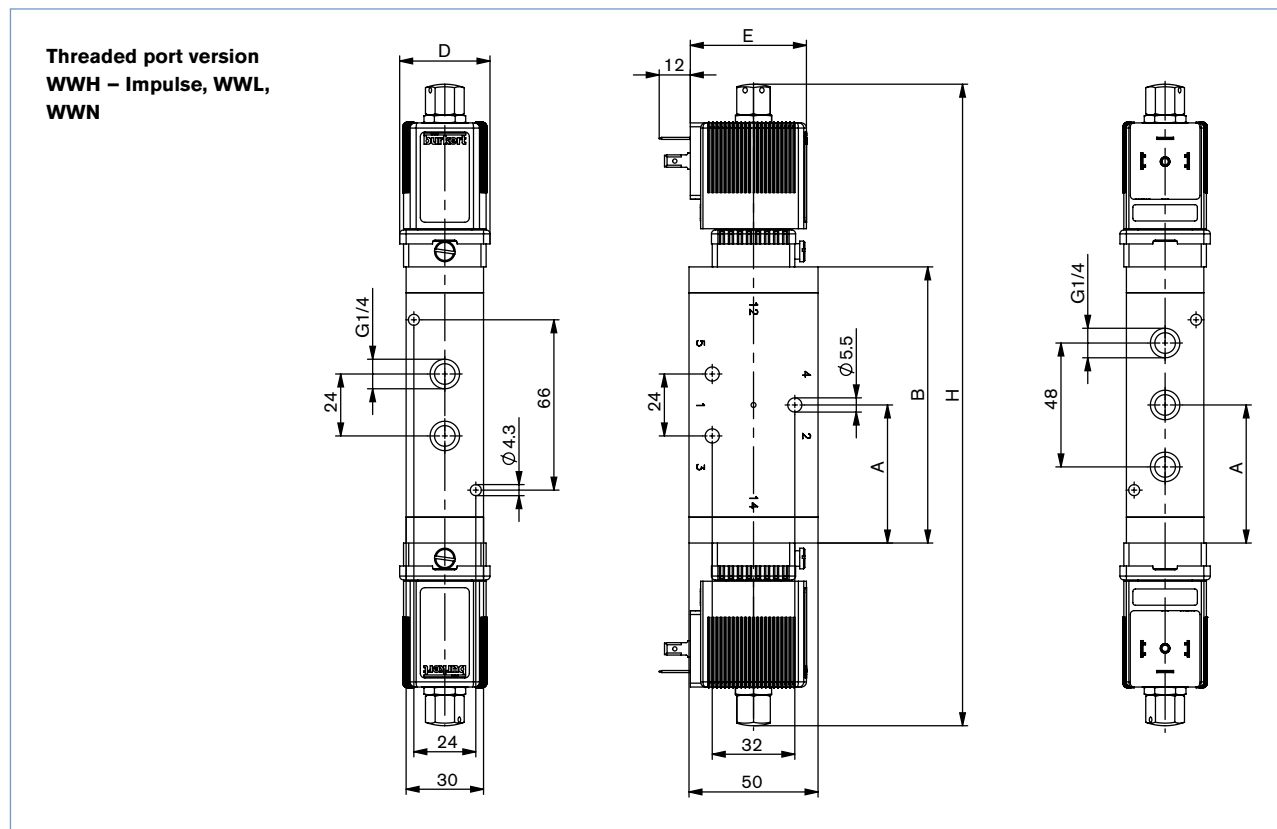
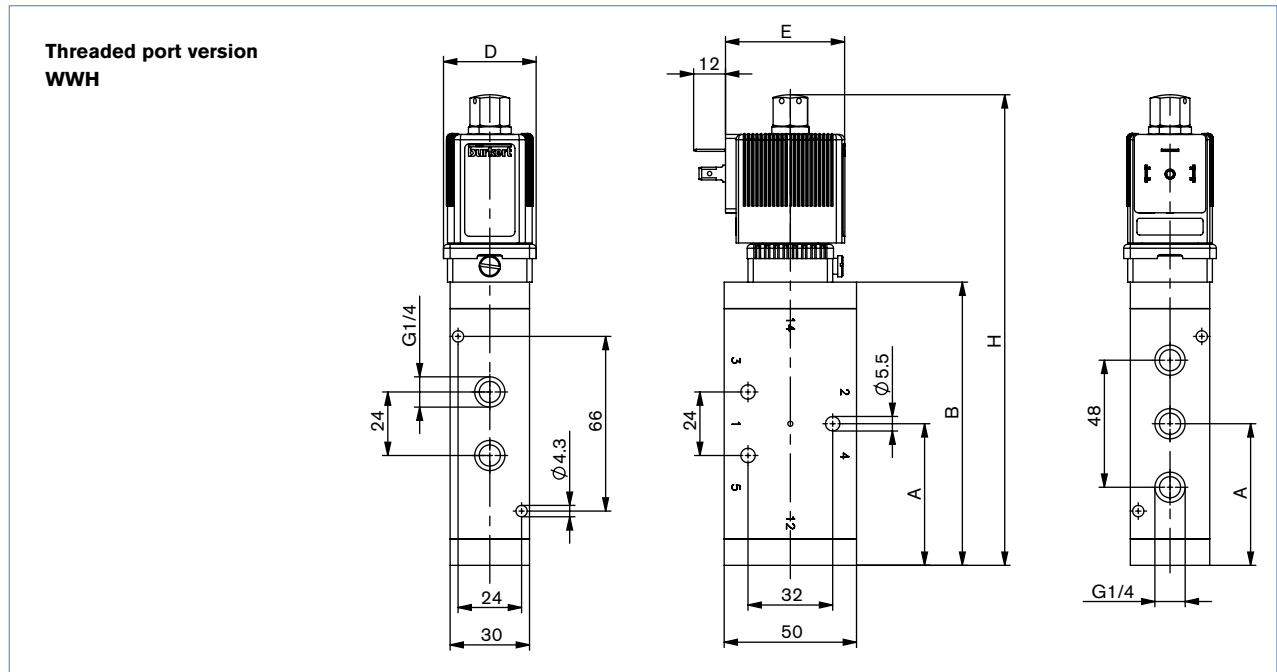

Version	Variants	A	B	D		E		H	
				Standard, Ex m	Ex i	Standard, Ex m	Ex i	Standard, Ex m	Ex i
WWH	Stainless steel	53.5	107	35	40.7	45	51	177.8	186.6
WWH	Aluminium	43.5	97	35	40.7	45	51	167.8	176.6
WWH – Impulse, WWL, WWN	Stainless steel	53.5	107	35	40.7	45	51	248.6	266.2
WWH – Impulse, WWL, WWN	Aluminium	53.5	107	35	40.7	45	51	148.6	266.2

Dimensions [mm]

NAMUR version
WWC

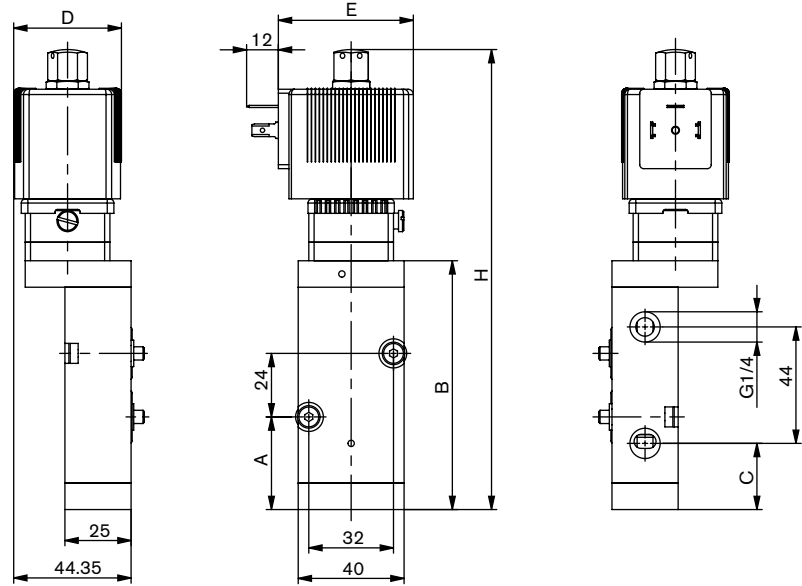

NAMUR version
WWH

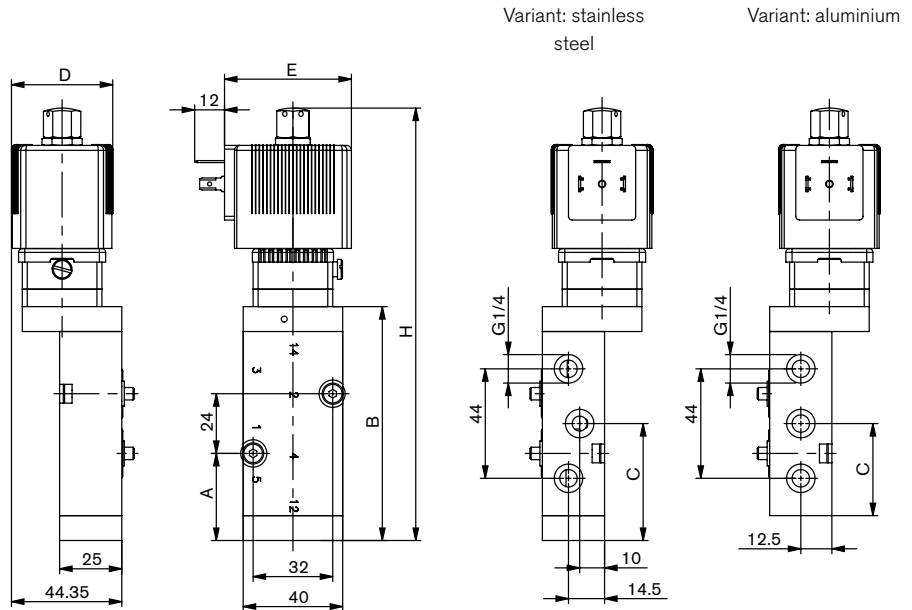

Version	Variants	A	B	C	D		E		H	
					Standard, Ex m	Ex i	Standard, Ex m	Ex i	Standard, Ex m	Ex i
WWC	Stainless steel	35	94	25	35	40.7	45	51	165	173.8
WWC	Aluminium	25	84	15	35	40.7	45	51	155	163.8
WWH	Stainless steel	35	94	47	35	40.7	45	51	165	173.8
WWH	Aluminium	25	84	37	35	40.7	45	51	155	163.8
WWH – Impulse, WWL, WWN	Stainless steel	35	94	47	35	40.7	45	51	236	253.6
WWH – Impulse, WWL, WWN	Aluminium	35	94	47	35	40.7	45	51	236	253.6

6519
for extended
temperature range

Dimensions [mm]

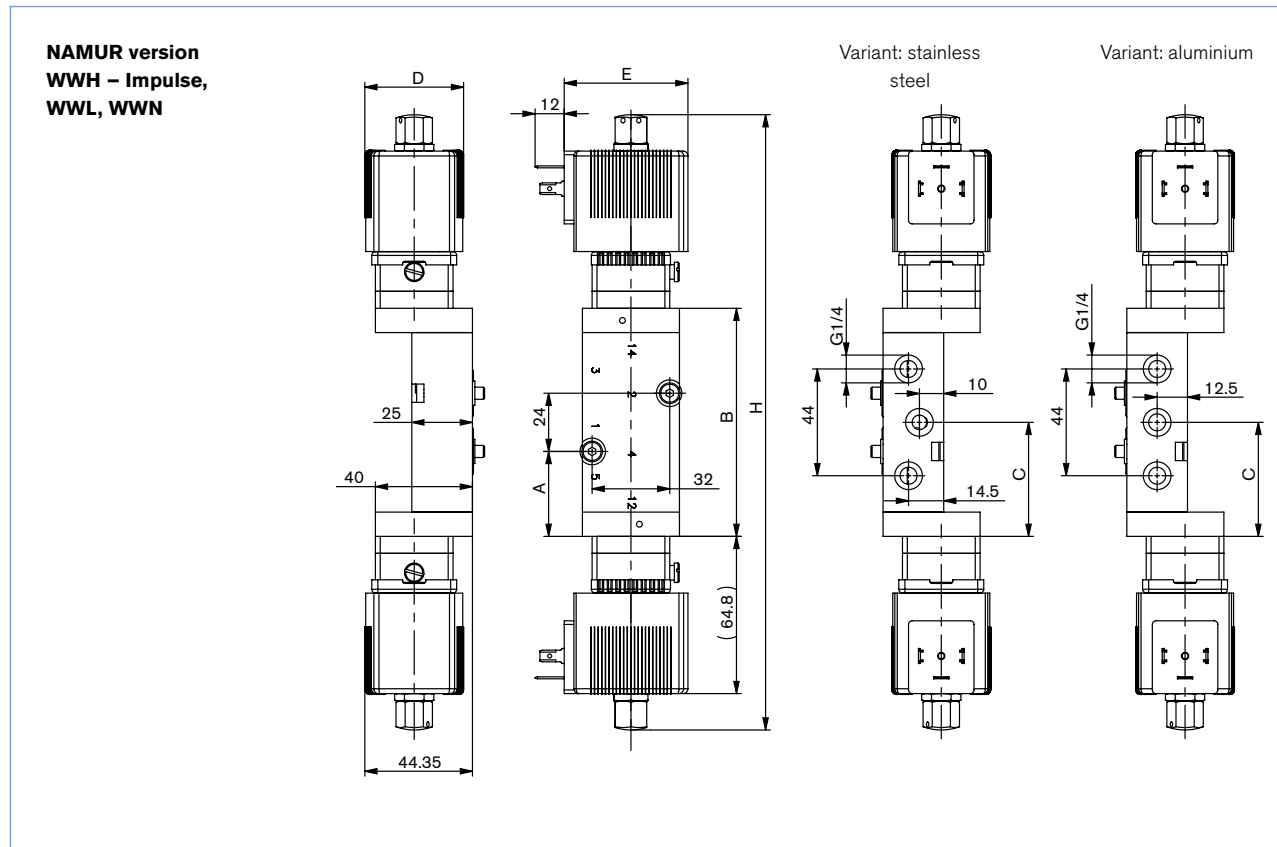

Version	Variants	A	B	C	D		E		H	
					Standard, Ex m	Ex i	Standard, Ex m	Ex i	Standard, Ex m	Ex i
WWC	Stainless steel	35	94	25	35	40.7	45	51	165	173.8
WWC	Aluminium	25	84	15	35	40.7	45	51	155	163.8
WWH	Stainless steel	35	94	47	35	40.7	45	51	165	173.8
WWH	Aluminium	25	84	37	35	40.7	45	51	155	163.8
WWH – Impulse, WWL, WWN	Stainless steel	35	94	47	35	40.7	45	51	236	253.6
WWH – Impulse, WWL, WWN	Aluminium	35	94	47	35	40.7	45	51	236	253.6

6519
for extended
temperature range

Dimensions - Atex Approvals [mm]

Cable coil

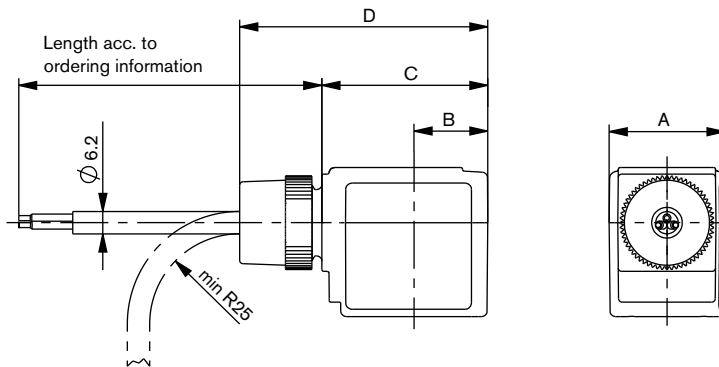

Junction box

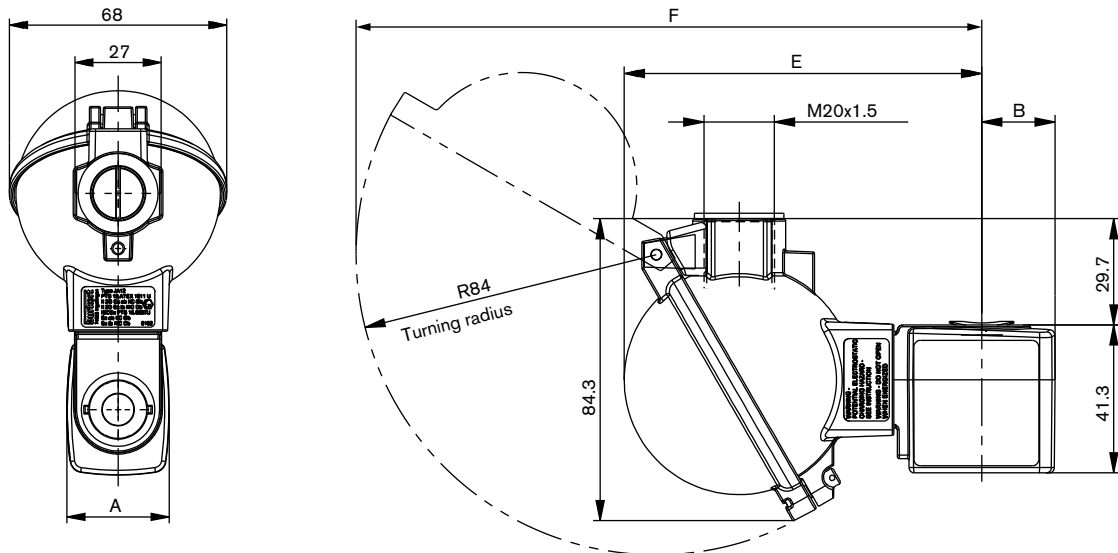

Coil size	A	B	C	D	E	F
5	32	20.5	46	68.8	99.8	174.7
6	40	23.5	52	74.8	102.8	177.7

To find your nearest Bürkert facility, click on the orange box → www.burkert.com

In case of special application conditions,
please consult for advice.

Subject to alterations
© Christian Bürkert GmbH & Co. KG

1809/17_EU-en_00891764