





## Electromotive 2/2 way angle seat valve

- Fail-safe position by energy storage
- Rapid flow shut off
- Weather and impact resistant design
- Designed according to hygienic demands
- Many diagnostic functions

Product variants described in the data sheet may differ from the product presentation and description.

### Can be combined with

	<b>Type 3360</b> Electromotive 2 way angle seat control valve	▶
	<b>Type 3361</b> Electromotive 2 way globe control valve	▶
	<b>Type 3321</b> Electromotive 2/2 way globe valve	▶

### Type description

The innovative Bürkert On/Off process valve Type 3320 is the solution when it comes to shut-off tasks under demanding operating conditions. The electromotive actuator with ball screw moves the swivel plate at a particularly high rate of 6 mm/s to its end position. Thereby it reacts almost instantaneously to process signals. If necessary, the safety position can be approached by an optional energy storage in case of power failure.

The actuator and shut-off valve are adapted perfectly to each other with closed design and robust surface. This ensures the hygienic requirements of a fast and residue-free cleaning.

Harsh environments are no problem for the Type 3320 because of the protection class IP65/IP67 and its high impact and vibration resistance. Unrivalled cycle life and sealing integrity is guaranteed by the proven self adjusting spindle packing with exchangeable V-seals.

The fieldbus suitable for Type 3320 provides many helpful functions for process monitoring, valve diagnostics and predictive maintenance and thus offers the decisive advantage of a modern process automation.

## Table of contents

<b>1. General Technical Data</b>	<b>3</b>
<hr/>	
<b>2. Approvals</b>	<b>4</b>
<hr/>	
<b>3. Materials</b>	<b>5</b>
3.1. Chemical Resistance Chart – Bürkert resistApp.....	5
3.2. Material specifications .....	5
<hr/>	
<b>4. Dimensions</b>	<b>7</b>
4.1. Complete valve Type 3320.....	7
4.2. Body with threaded connection.....	9
4.3. Body with welded connection .....	10
4.4. Body with clamp connection .....	11
<hr/>	
<b>5. Performance specifications</b>	<b>12</b>
5.1. Fluidic data .....	12
Overview of flow characteristics with flow below seat .....	12
5.2. Operating limits.....	13
Operating limits for medium temperature and operating pressure.....	13
Operating limits ambient and medium temperature .....	14
Operating limits valve seat seal .....	14
Operating limits for optional versions .....	14
5.3. Electrical control and interfaces .....	15
Interface diagram.....	15
<hr/>	
<b>6. Product design and assembly</b>	<b>16</b>
6.1. Product features .....	16
6.2. Product assembly .....	18
<hr/>	
<b>7. Ordering information</b>	<b>19</b>
7.1. Bürkert eShop – Easy ordering and quick delivery.....	19
7.2. Bürkert product filter.....	19
7.3. Ordering chart accessories.....	19

## 1. General Technical Data

Product properties	
Dimensions	Detailed information can be found in chapter <b>"4. Dimensions"</b> on page 7.
Material	Detailed information can be found in chapter <b>"3. Materials"</b> on page 5.
Design	Angle seat on/off valve
Nominal diameter	DN15...50, NPS ½...2
Flow direction	Against closing direction (below seat)
Safety setting in case of power failure	With SAFEPOS energy-pack: open, closed or freely programmable Without SAFEPOS energy-pack: blocked in last position
Weight	4 kg (only actuator, total weight depends on the port connection)
Performance data	
Operating pressure	0...25 bar(g) (see <b>"5.1. Fluidic data"</b> on page 12) Vacuum version up to -0.9 bar(g) (optional)
Nominal pressure (max.)	PN25 (DIN EN 1333), Class 150 (DIN EN 1759)
K <sub>v</sub> value	5...62 m <sup>3</sup> /h (see <b>"5.1. Fluidic data"</b> on page 12)
Closing time	2.3...6.2 s (depending on travel speed and stroke)
Travel speed	6 mm/s (for actuator force 1300 N) 4 mm/s (for actuator force 2500 N)
Electrical data	
Operating voltage	24 V DC ± 10 % (max. residual ripple 10 %)
Operating current <sup>1.)</sup>	Max. 3 A (at max. load and including 1 A charging current of the optional SAFEPOS energy-pack) At minimum operating temperature additionally 2 A
Protection class (DIN EN 61140)	3
Duty cycle	100 %
Standby consumption <sup>1.)</sup>	2...4 W
Communication and control	
Standard signals (analogue)	0...5 V (log. 0) 10...30 V (log. 1)
Fieldbus (digital)	Bürkert system bus (bÜS) (Standard) CANopen (optional) EtherNet/IP, PROFINET, Modbus/TCP (optional via integrated gateway)
Media data	
Medium	Steam, neutral gases, water, alcohols, oils, fuels, hydraulic fluids, salt solutions, lyes, organic solvents, oxygen (optional)
Medium temperature	-40...+230 °C (see <b>"5.2. Operating limits"</b> on page 13)
Viscosity	Up to 600 mm <sup>2</sup> /s
Process/Port connection & communication	
Port connection <sup>2.)</sup>	
Threaded connection	G (EN ISO 228 - 1) Rc (ISO 7/1/DIN EN 10226 - 2) NPT (ASME B 1.20.1)
Welded connection	DIN EN ISO 1127/ISO 4200/DIN11866 B DIN 11850 2/DIN 11866 A ASME BPE/DIN 11866 C SMS 3008
Clamp connection	DIN 32676 B (pipe ISO 4200) DIN 32676 A (pipe DIN 11850 2) ASME BPE
Electrical connection	
Actuator	Terminal strip with cable gland, 2 x M20 or 2 M12 circular plugs, 5 pin and 8 pin
Fieldbus gateway	2 M12 circular sockets, 4 pin (only with Industrial Ethernets)
Approvals and certificates	
Conformity	Food EGV 1935/2004 FDA (optional)
Approvals	Explosion protection ATEX/IECEX (optional) (see <b>"2. Approvals"</b> on page 4) cULus Cert. No. 238179 (optional) (see <b>"2. Approvals"</b> on page 4)
Ignition protection class	II 3G Ex ec IIC T4 Gc II 3D Ex tc IIIC T135 °C Dc

**Environment and installation**

Ambient temperature	-25...+65 °C (only without additional modules) (De-rating see " <a href="#">Operating limits ambient and medium temperature</a> " on page 14)
Degree of protection	IP65/IP67 (DIN EN 60529), NEMA 4X







**Vibration and shock resistance**

Vibration, sinusoidal	5 g (IEC 60068 - 2 - 6 Test Fc)
Shock, mechanical	50 g (IEC 60068 - 2 - 27 Test Ea)
Installation position	Any, preferably actuator face up

1.) All values refer to a supply voltage of 24 V at 25 °C.

2.) Others on request

**2. Approvals**

Approvals	Description
	<b>Food produce contact</b> Materials in contact with medium conform to EC regulation 1935/2004 (optional) Materials in contact with medium conform to FDA (optional)
	<b>Drinking water</b> Suitable for use with drinking water according to KTW, W270 (optional)
	<b>Oxygen</b> Suitable for use with gaseous oxygen (optional)
 	<b>Explosion proof</b> As category 3 device suitable for zone 2/22 (optional)  <b>ATEX</b> <ul style="list-style-type: none"> <li>• II 3G Ex ec IIC T4 Gc</li> <li>• II 3D Ex tc IIIC T135 °C Dc</li> </ul> <b>IECEX</b> <ul style="list-style-type: none"> <li>• Ex ec IIC T4 Gc</li> <li>• Ex tc IIIC T135 °C Dc</li> </ul>
	<b>Safety requirements</b> UL-listed cULus Cert. No. 238179 (optional)
Standards	Description
	Field device for integration into the EDIP platform via Bürkert system bus (bÜS)

### 3. Materials

#### 3.1. Chemical Resistance Chart – Bürkert resistApp



**Bürkert resistApp – Chemical Resistance Chart**

You want to ensure the reliability and durability of the materials in your individual application case? Verify your combination of media and materials on our website or in our resistApp.

[Start Chemical Resistance Check](#)

#### 3.2. Material specifications

**Note:**

The Type 3320 angle seat valve is supplied with various port connections (flange, thread, welded and clamp connections). These connections are not shown. They are the same material as the valve body.

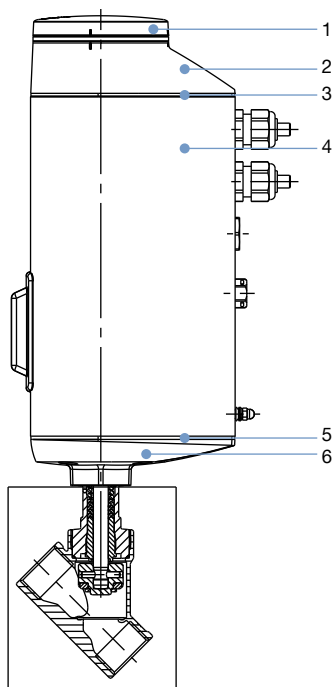

No.	Component	Material
1	Blind cover	PPS (Standard), Stainless steel 1.4301 (for ATEX/IECEx)
2	Actuator cover	PPS
3	Seal	EPDM
4	Actuator housing	Aluminium powder coated
5	Seal	EPDM
6	Actuator base	PPS

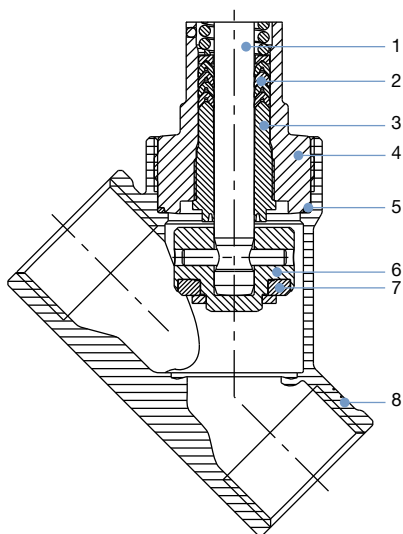

No.	Component	Material
1	Spindle	Stainless steel 1.4401 (316) /1.4404 (316L)
2	Spindle seal	PTFE V-seals (filled) with spring compensation
3	Spindle guidance	PEEK
4	Packing gland tube	Stainless steel 1.4401 (316)
5	Seal valve body	Graphite or PTFE
6	Swivel plate	Stainless steel 1.4401 (316)/1.4404 (316L)
7	Valve seat seal	PTFE or PEEK sealing washer
8	Valve body	Stainless steel CF3M

## 4. Dimensions

### 4.1. Complete valve Type 3320

**Note:**

Dimensions in mm, unless otherwise stated

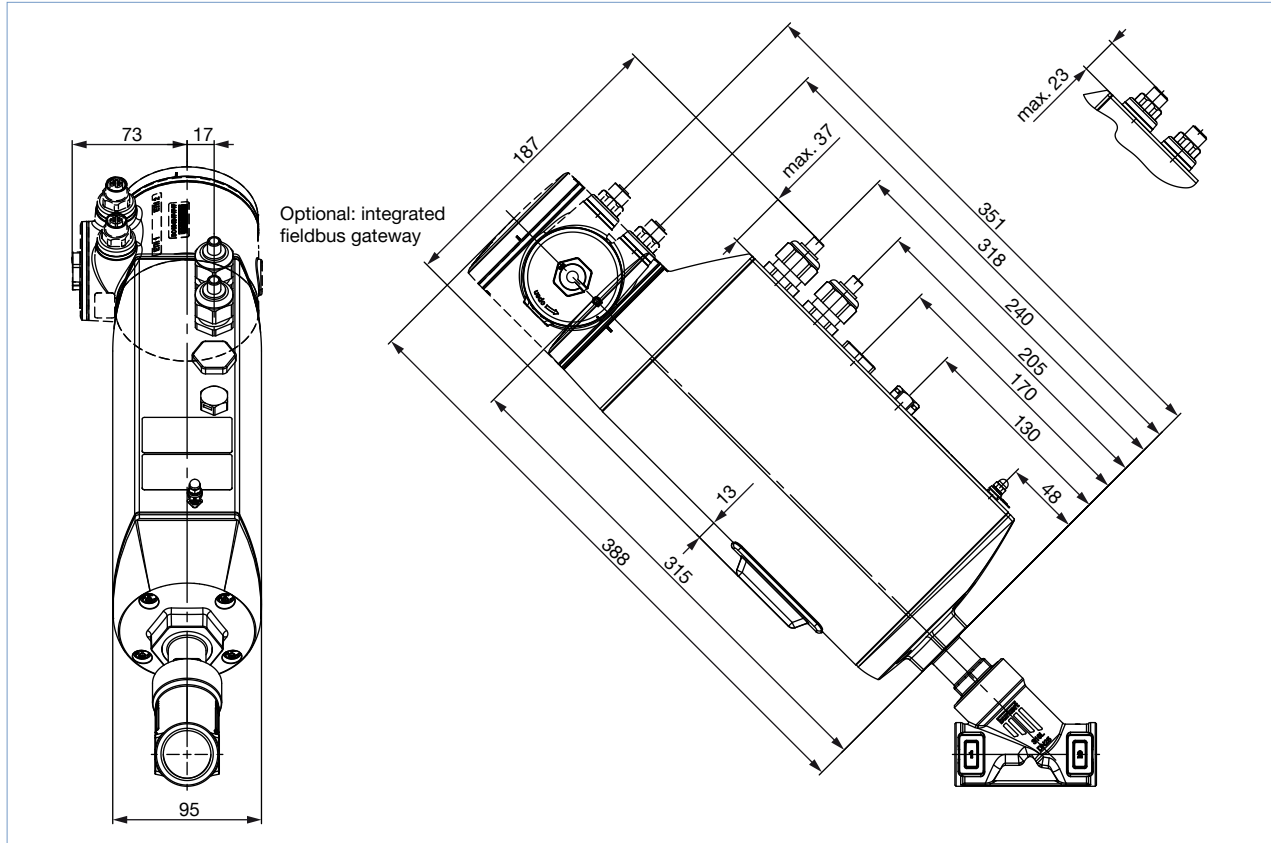

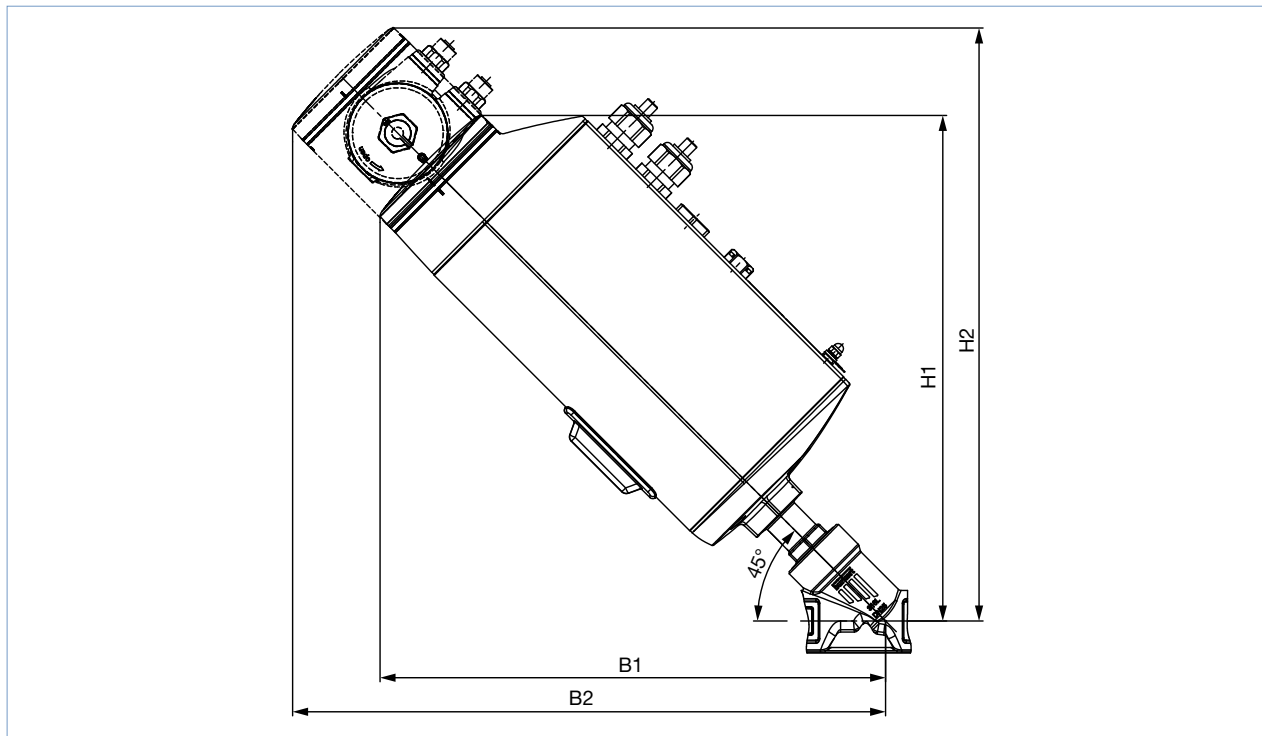

Nominal diameter (Pipe)		Height/Width <sup>1.)</sup>	
DN	NPS	H1/B1	H2/B2 <sup>2.)</sup>
15	1/2	311	362
20	3/4	319	369
25	1	321	372
32	1 1/4	330	381
40	1 1/2	333	384
50	2	367	418

1.) Dimensions without tight-closing function: in closed position the actuator additionally lifts by approx. 2 mm. Body with threaded connection.  
 2.) Optional: integrated fieldbus gateway



### 4.2. Body with threaded connection

**Note:**

Dimensions in mm, unless otherwise stated

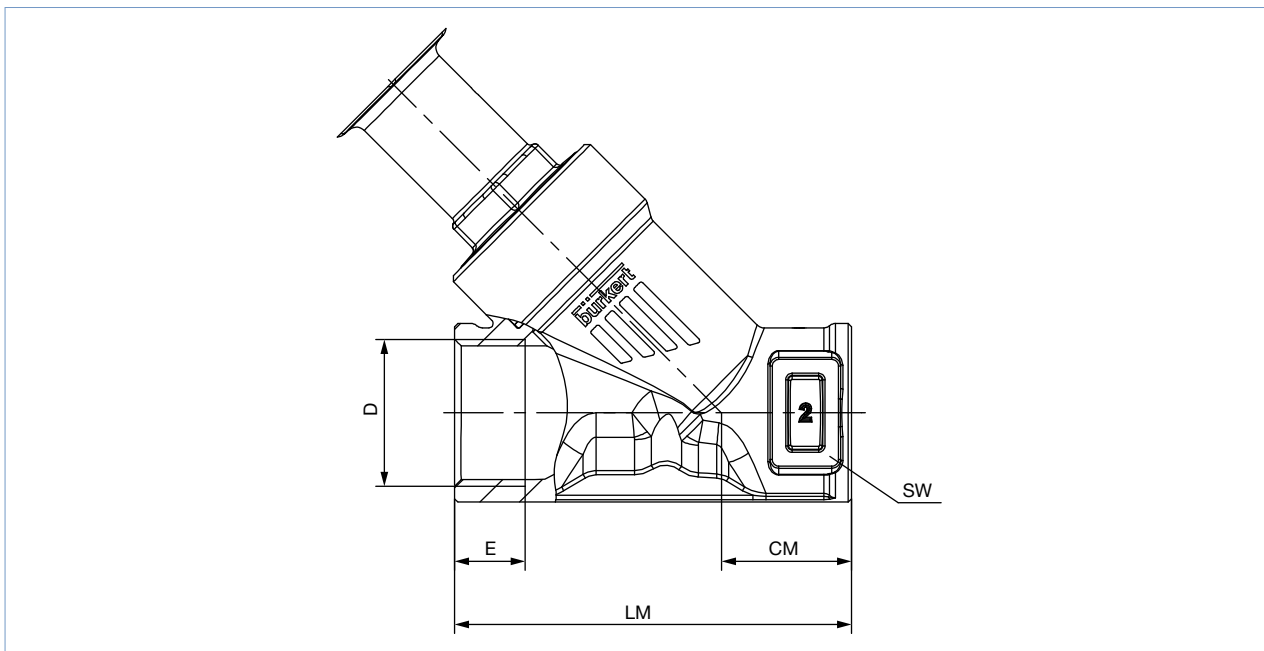

Nominal diameter (Pipe)	G (DIN ISO 228 - 1), NPT (ASME B 1.20.1), Rc (ISO7 - 1)				CM	LM	SW
	D	E					
DN	NPS	G	NPT	Rc			
15	½	14	13.7	13.2	24	65	27
20	¾	16	14.0	14.5	27	75	34
25	1	18	16.8	16.8	29.5	90	41
32	1¼	16	17.3	19.1	36	110	50
40	1½	18	17.3	19.1	35	120	55
50	2	24	17.6	23.4	45	150	70

DTS 1000295547 EN Version: N Status: RL (released | freigegeben | valide) printed: 22.07.2021

### 4.3. Body with welded connection

**Note:**

Dimensions in mm, unless otherwise stated

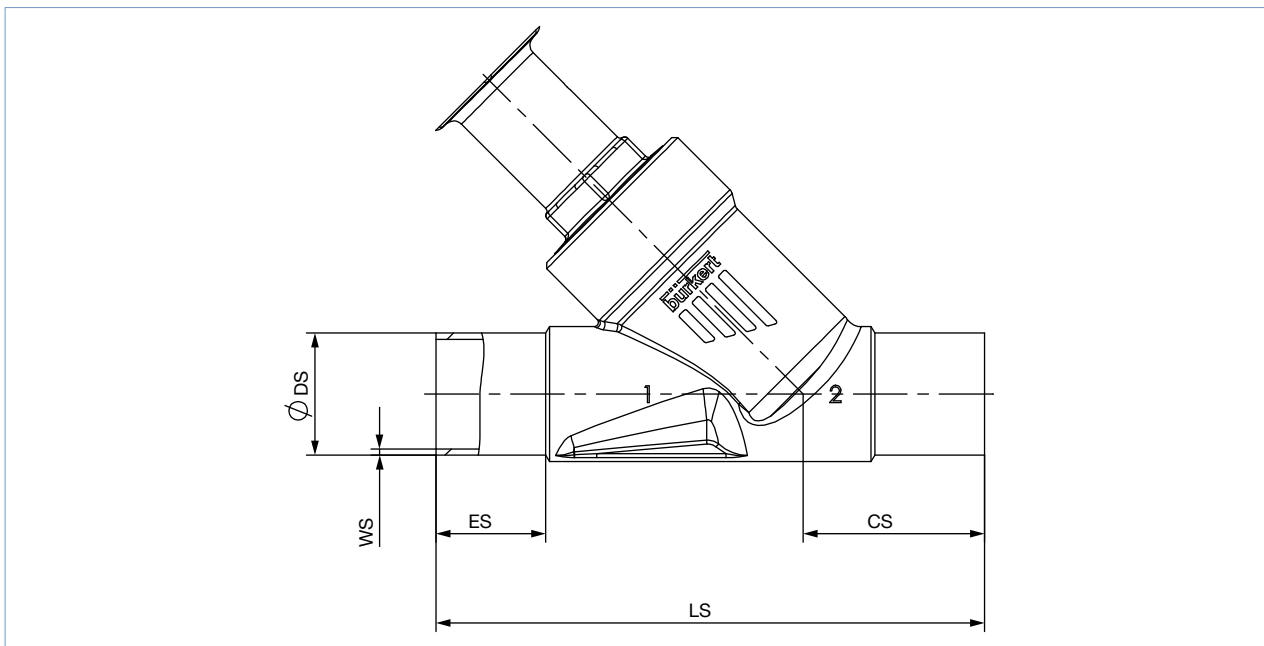

Nominal diameter (Pipe)	DIN EN ISO 1127 ISO 4200 DIN 11866 B					DIN 11850 2 DIN 11866 A				
	DN	ES	CS	LS	ØDS	WS	ES	CS	LS	ØDS
15	19	34	100	21.3	1.6	19	34	100	19	1.5
20	20	39	115	26.9	1.6	20	39	115	23	1.5
25	26	43	130	33.7	2.0	26	43	130	29	1.5
32	26	45	145	42.4	2.0	26	45	145	35	1.5
40	26	49	160	48.3	2.0	26	49	160	41	1.5
50	26	50	175	60.3	2.0	26	50	175	53	1.5

Nominal diameter (Pipe)	ASME BPE DIN 11866 C				
NPS	ES	CS	LS	ØDS	WS
½	30	46	135	12.7	1.65
¾	30	52	145	19.05	1.65
1	30	51	152	25.4	1.65
1½	30	60	182	38.1	1.65
2	30	64	210	50.8	1.65
2½	26	56	230	63.5	1.65

DTS 1000295547 EN Version: N Status: RL (released | freigegeben | validé) printed: 22.07.2021

4.4. Body with clamp connection

**Note:**

Dimensions in mm, unless otherwise stated

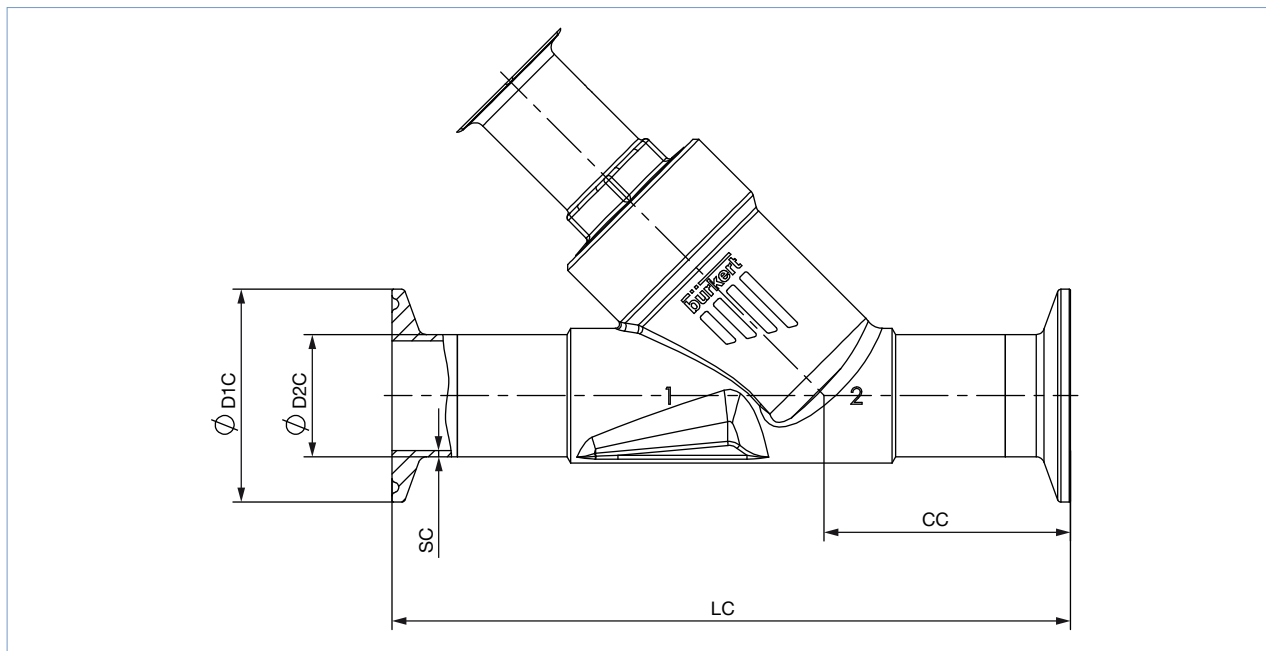

Nominal diameter (Pipe)	Clamp: DIN 32676 B					Clamp: DIN 32676 A				
	Pipe: EN ISO 1127 1 ISO 4200 DIN 11866 B					Pipe: DIN 11850 2 DIN 11866 A				
DN	LC	CC	ØDC1	ØDC2	SC	LC	CC	ØDC1	ØDC2	SC
15	156	49.0	50.5	21.3	1.6	130	49.5	19	34.0	1.5
20	150	56.5	50.5	26.9	1.6	150	57.0	23	34.0	1.5
25	160	58.0	50.5	33.7	2.0	160	58.5	29	50.5	1.5
32	200	57.5	50.5	42.4	2.0	180	58.0	35	50.5	1.5
40	200	69.0	64.0	48.3	2.0	200	69.5	41	50.5	1.5
50	230	77.5	77.5	60.3	2.6	230	78.0	53	64.0	1.5

Nominal diameter (Pipe)	Clamp: ASME BPE				
	Pipe: ASME BPE DIN 11866 C				
NPS	LC	CC	ØDC1	ØDC2	SC
½	130	49.0	25.0	12.7	1.65
¾	150	56.5	25.0	19.05	1.65
1	160	58.0	50.5	25.4	1.65
1½	200	69.0	50.5	38.1	1.65
2	230	77.5	64.0	50.8	1.65

DTS 1000295547 EN Version: N Status: RL (released | freigegeben | valide) printed: 22.07.2021

## 5. Performance specifications

### 5.1. Fluidic data

Overview of flow characteristics with flow below seat

Note:

- $K_v$  value [m<sup>3</sup>/h]: Measured with water acc. to DIN EN 60534-2-3
- Operating limits, see [“5.2. Operating limits” on page 13](#)

Nominal diameter (Pipe)		Actuator force [N]	Operating pressure		$K_v$ value [m <sup>3</sup> /h]
DN	NPS		Seat seal		
			PTFE (up to +130 °C)	PEEK (up to +230 °C)	
			[bar(g)]		
15	½	1300	25	25	5
20	¾				11
25	1				18
32	1¼	1300	16	16	31
		2500	25	25	
40	1½	1300	10	10	42
		2500	18	18	
50	2	1300	6	6	62
		2500	10	10	

## 5.2. Operating limits

### Operating limits for medium temperature and operating pressure

The operating range of Bürkert process valves is in addition to the maximum operating pressures limited by the nominal pressure according to the relevant standard.

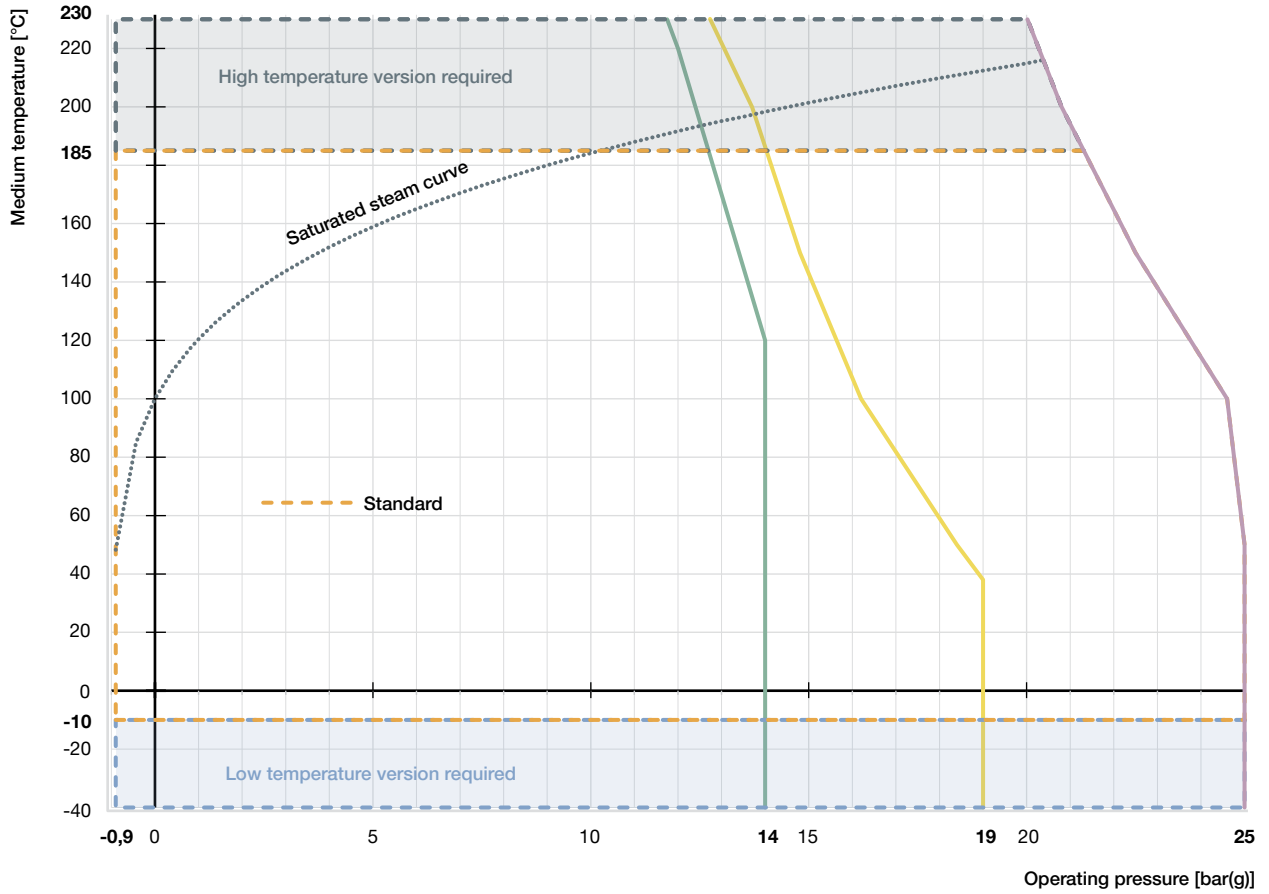

- Operating limits for PN25 acc. to DIN EN 12516-1
- Operating limits for flange 10K acc. to JIS B 2220
- Operating limits for Class 150 acc. to ASME B16.34
- ⋯ Saturated steam curve for water

### Operating limits ambient and medium temperature

The maximum permissible temperature for the environment and the medium are dependent on each other. The maximum allowable temperature curves of different device variants can be seen in the temperature chart. The curves were determined for maximum operating conditions (max. operating pressure and motor power). For deviating operating conditions an individual verification can be performed. Please contact your Bürkert office for more information.

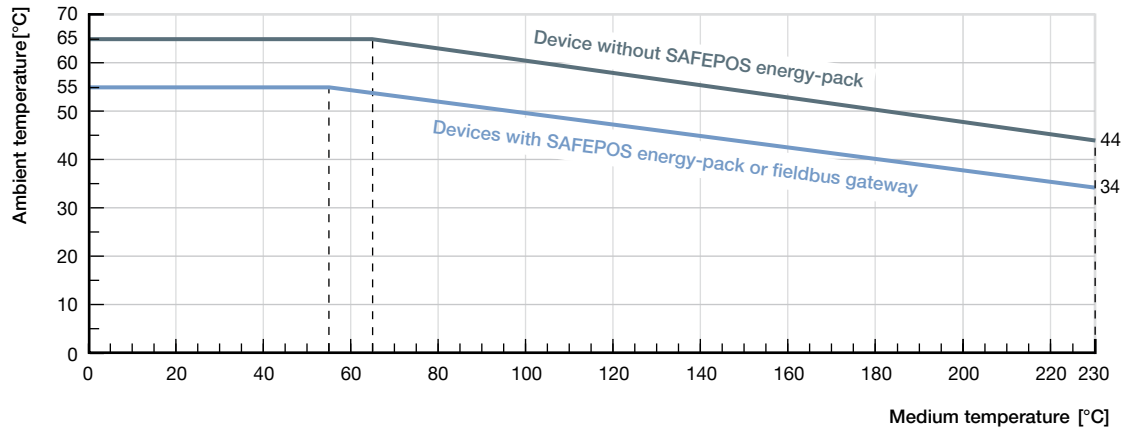

### Operating limits valve seat seal

PTFE is used for max. medium temperature < 130 °C. If the maximum medium temperature temporarily or permanently exceeds 130 °C, then PEEK as a seal material is the appropriate solution.

### Operating limits for optional versions

#### High temperature version

By adapting the spindle sealing this version is suitable for applications with steam, neutral gases and other heat transfer mediums up to 230 °C.

#### Drinking water version

Materials in contact with the medium are tested for suitability with drinking water up to 85 °C.

#### Vacuum version

Without leakage bore, this design is suitable for pressures down to -0.9 bar(g).

#### Low temperature version

Suitable for minimum medium temperatures down to -40 °C

#### Version for oxygen

Non-metallic materials in contact with the medium are tested for suitability with oxygen. Suitable for operating pressures up to 20 bar(g) and medium temperatures up to 60 °C.

### 5.3. Electrical control and interfaces

#### Interface diagram

The position of the actuator is controlled according to the digital input. The selection is made either by an external standard signal or via a fieldbus (digital).

#### Inputs and outputs:

- 1 digital input, 2 digital outputs

#### Interface:

- Cable gland with connection terminal
- M12 circular plug-in connectors (optional)

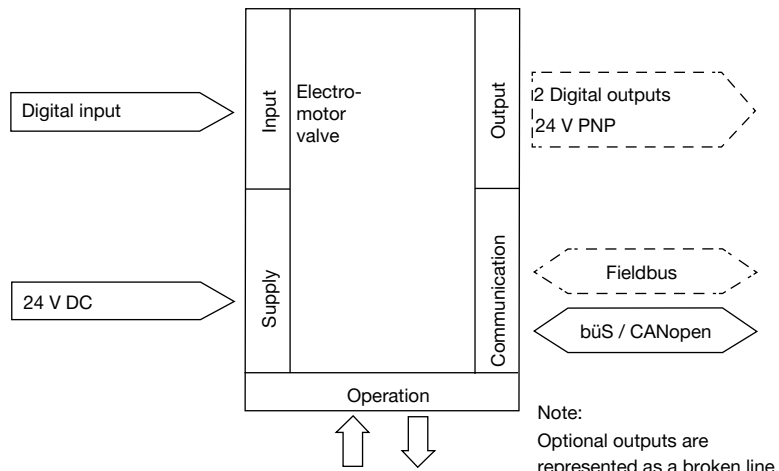

Control data	
Digital input	0...5 V = log "0", 10...30 V = log "1" inverted input reversed accordingly
Digital output (optional)	Current limitation 100 mA
Communication	
Communication interface (bÜS)	Connection to PC via USB bÜS interface set (connection terminals, circular plug-in connector or bÜS service interface)
Communication software (bÜS)	Bürkert Communicator, see <b>Type 8920</b> ▶

## 6. Product design and assembly

### 6.1. Product features

**Note**

More detailed information can be found in the **operating instructions** ►

<p><b>User interface</b></p> <p>The basic functions are operated by 4 DIP switches and 2 push buttons. These are located under the blind cover which can be removed manually by turning. Through the būs service access, the device can also be configured in detail with the Bürkert communicator software. For this, the optional USB-būs interface kit is required.</p>	<p><b>Blind cover dismantled</b></p>
<p><b>Actuation</b></p> <p><b>Mechanical manual control:</b> The manual override for mechanical movement of the valve is located under the blind cover.</p> <p><b>Electrical control via operating elements:</b> The electrical manual override for the procedure is carried out via two buttons under the blind cover.</p>	
<p><b>Display elements</b></p> <p><b>Display:</b> 360° LED light ring: A clearly visible 360° LED ring is attached to the blind cover or display module to indicate the device status, the valve end position and the operating status. The LED light ring lights up, blinks or flashes into one or changing colours, depending on the LED mode set</p> <p><b>Mechanical position indicator:</b> The mechanical position indicator shows the current valve position even if the supply voltage fails.</p>	
<p><b>Data transmission (optional)</b></p> <p><b>SIM card (optional):</b> With the optionally available SIM card, device-specific values and user settings can be stored and quickly transferred to another device.</p>	
<p><b>būs service interface:</b> The būs service interface connects the device with the Communicator software on a PC, laptop or smartphone. From there a configuration of the device or error diagnosis can be carried out.</p>	

DTS 1000295547 EN Version: N Status: RL (released | freigegeben | valide) printed: 22.07.2021



**Safety position via energy storage (optional)**

The safety starting positions in case of power interruption is realized with the optional energy storage SAFEPOS energy-pack. The desired position is set via the menu. In addition to the end positions (open/closed), any desired intermediate position can be defined here. The energy storage has a lifespan of up to 10 years, depending on the operating conditions. The power of the energy storage is monitored and a warning is displayed to indicate its life is coming to an end. The storage device is designed as a plug-in module to facilitate replacement. Without energy storage, the valve remains in the last position it was in. The energy storage device is fully charged and ready for operation after a maximum of 100 seconds (depending on the operating conditions). The energy storage device cannot be retrofitted in the field.

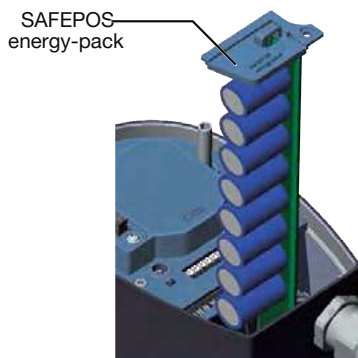

**Fieldbus: EtherNet/IP, PROFINET, Modbus TCP (optional)**

The fieldbus gateway for EtherNet/IP, PROFINET and Modbus TCP is integrated in an additional module. It has 2 fieldbus connections with 4 pin M12 circular sockets. The interfaces for the fieldbus connection and the status LEDs are located under the gateway housing cover. If there is a need for it to be include in a network then the configuration of the Ethernet can be performed via the web server. The gateway cannot be retrofitted in the field.

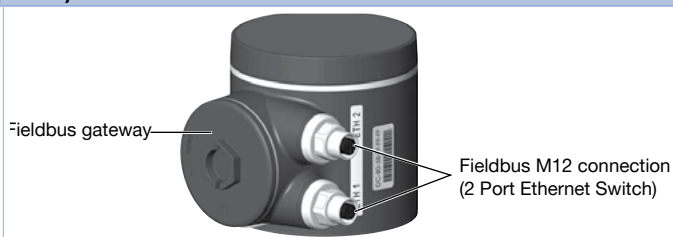

DTS 1000295547 EN Version: N Status: RL (released | freigegeben | valide) printed: 22.07.2021

## 6.2. Product assembly

The electromotive linear drive consists of a brushless DC motor, a gear and a spindle system that transmits the force to the pendulum plate. The integrated control electronics are controlled either via standard signals (digital) or via a fieldbus (digital). It is designed to provide optimum efficiency. At the same time, it keeps the valve sealed and in position even at the maximum specified medium pressure in a powerless standstill. An optional energy storage device (SAFEPOS energy-pack) is available for the device. If the supply voltage fails, it supplies the actuator with the energy required to move the valve into the desired position; this is set in the menu. The valve position can be changed manually in 2 ways. Either via the electrical manual control or via a mechanical manual control if no supply voltage is available.

The device can be set and operated via 2 capacitive keys and 4 DIP switches. In addition there is always the possibility to operate the device via the bus service interface and using the "Bürkert Communicator" software.

The intelligent process valve Type 3320 offers the operator options for process monitoring, valve diagnostics and preventive maintenance. Internal measurements of the operating status are evaluated and issued as warnings or error messages, if necessary. These indicate, for example, impermissible ambient and process conditions, functional deviations of components or the status of the energy storage device.

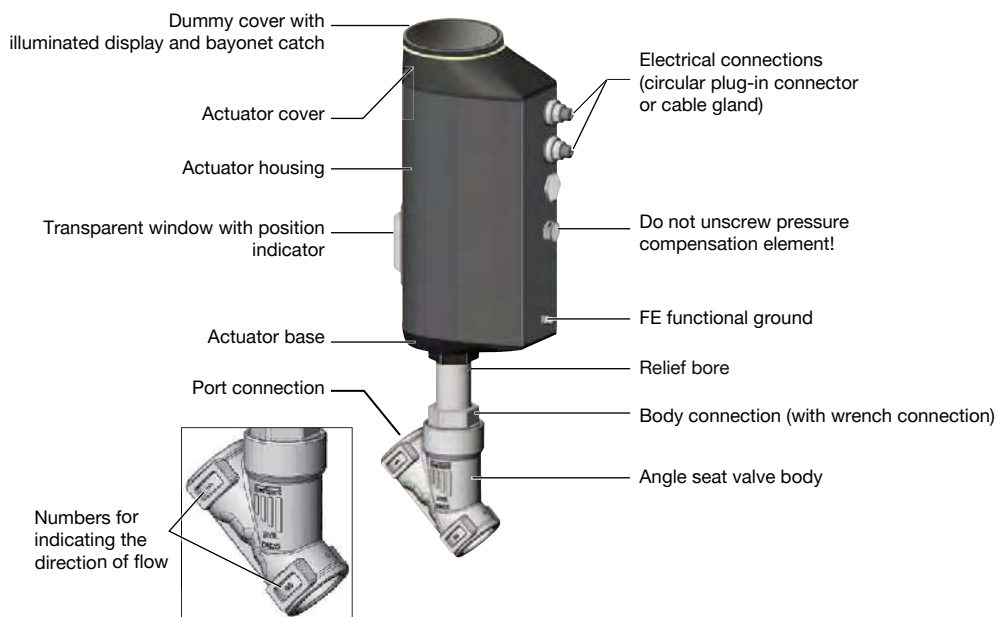

## 7. Ordering information

### 7.1. Bürkert eShop – Easy ordering and quick delivery



#### Bürkert eShop – Easy ordering and fast delivery

You want to find your desired Bürkert product or spare part quickly and order directly? Our online shop is available for you 24/7. Sign up and enjoy all the benefits.

[Order online now](#)

### 7.2. Bürkert product filter



#### Bürkert product filter – Get quickly to the right product















You want to select products comfortably based on your technical requirements? Use the Bürkert product filter and find suitable articles for your application quickly and easily.

[Try out our product filter](#)

### 7.3. Ordering chart accessories

#### Note:

For connection to a bus/CANopen network see [cabling guide](#) ►.

Description	Article no.
<b>Connection cable</b>	
Connection cable with M12 socket, 4 pin, (length 5 m) for operating voltage (without communication)	918038 
Connection cable with M12 socket, 8 pin, (length 2 m) for input and output signals	919061 
<b>USB-büS interface set</b>	
büS stick set 1 (including power supply unit, bus-stick, terminating resistor, Y-distributor, 0.7 m cable with M12 connector)	772426 
büS stick set 2 (including bus-stick, terminating resistor, Y-distributor, 0.7 m cable with M12 connector)	772551 
büS adapter for büS interface set (M12 on büS service interface Micro-USB)	773254 
<b>büS cable extensions from M12 plug to M12 socket</b>	
Connecting cable, length 1 m	772404 
Connecting cable, length 3 m	772405 
Connecting cable, length 5 m	772406 
Connecting cable, length 10 m	772407 
<b>Miscellaneous</b>	
Software Bürkert Communicator, Type 8920	<b>LINK ►</b>
SIM card	291773 
Holding device for port connection DN15...20	693770 
Holding device for port connection DN25...50	693771 
Blind cover made of plastic	277881 
Energy storage SAFEPOS energy-pack	285834 

# Bürkert – Close to You

For up-to-date addresses  
please visit us at  
[www.burkert.com](http://www.burkert.com)

DTS 1000295547 EN Version: N Status: RL (released | freigegeben | validé) printed: 22.07.2021



## Product Enquiry Form - Electromotive Shut-off Valves

Thank you for your interest in our products! In order to provide you with optimum advice, please fill out the following form and send it to your **Bürkert representative** or e-mail address: [info@buerkert.com](mailto:info@buerkert.com). All information submitted will of course be kept strictly confidential.

Please fill in the required fields!  \*

\*Note: The interactive functions of this PDF may be restricted depending on the PDF reader used.

Personal Information			
Company		Contact person	
Customer no.		Department	
Street		Postcode / Town	
Telephone no.		Email	

Delivery	
Quantity	Required delivery date

Operating data			
Function <small>(Function of the control valve in the process / process description)</small>			
Pipeline	DN	PN	
Operating medium			
Type of medium	Fluid	Steam	Gas
Operating pressure	Unit		
Medium temperature	°C / °F		
Ambient temperature	°C / °F		

Valve body				
Construction	Angle seat valve		Globe valve	
Seat seal	PTFE		PEEK	
DN / Nominal pressure	DN		PN	
Flow coefficient	$K_v$	$m^3/h$	$C_v$	GPM(US)
Connection	Flange	DIN EN 1092-1		ANSI B16.5
	Thread	G		NPT
	Weld	DIN EN ISO 1127 / ISO 4200		DIN 11850 2 / DIN 11866 A
	Clamp	ASME BPE		DIN 32676 A (tube ISO 4200)
	Other			DIN 32676 B (tube DIN 11850)

Valve data	
Safety position	With energy storage (factory setting NO) With energy storage (factory setting NC) Without energy storage (last valve position blocked)
Electrical connection	Cable gland                      M12 multi-pin plug connection
Communication	<b>Digital:</b> 1 DI, 2 DO <b>Digital (Fieldbus):</b> EtherNet/IP      PROFINET      Modbus TCP CANopen
SIM card	With                      without

DTS 1000295547 EN Version: N Status: RL (released | freigegeben | valide) printed: 22.07.2021

<b>Approvals / Conformities</b>
For use with food (conform to EG regulation no. 1935/2004)
For use with food (conform to FDA)
Explosion protection in accordance with ATEX II 2GD mech. / IECex
European Gas Appliances Directive (EU) 2016/426, DVGW DIN EN 161 and DIN EN 16678
For potable water according to KTW/W270
Certificate for the fulfilment of the order EN-ISO 10204 2.1 (Article no. 440788)
Test report EN-ISO 10204 2.2 (Article no. 803722)
Conformity certification for raw material EN-ISO 10204 3.1 (included)

<b>Additional Requirements / Comment</b>

DTS 1000295547 EN Version: N Status: RL (released | freigegeben | valide) printed: 22.07.2021