



## Vibrating level switch

- For universal applications such as limit level detection or dry run protection system
- Installation without adjustment
- Smallest installation dimensions
- Available in IO-Link version

Product variants described in the data sheet may differ from the product presentation and description.

### Can be combined with

	<b>Type 2030</b> ▶ Pneumatically operated 2/2 way diaphragm valve CLASSIC with plastic body
	<b>Type 8644</b> ▶ Remote Process Actuation Control System AirLINE
	<b>Type 2301</b> ▶ Pneumatically operated 2 way Globe Control Valve
	<b>Type 8619</b> ▶ multiCELL - Multi-channel and multi-function transmitter/controller

### Type description

The Type 8110 is a filling level switch for liquids, using a tuning fork as the sensor element. It is designed for industrial use in all areas of process technology and can be used in liquids. Typical applications are overflow or dry run protection.

The small tuning fork (40 mm in length) can be used in vessels, tanks and tubes.

Due to the simple and rugged measuring system, the 8110 is virtually unaffected by the chemical and physical features of the liquid. It works even under unfavourable measurement conditions such as turbulence, air bubbles, foam generation (not suitable for measuring the foam thickness itself), adhesions, strong external vibrations or varying filling materials.

The digital interface IO-Link allows bidirectional data transfer with any IO-Link Master. Data access is done by using the available standardized IO-Link. IO-Link is in accordance to the specification version 1.0.

## Table of contents

<b>1. General Technical Data</b>	<b>3</b>
<hr/>	
<b>2. Product versions</b>	<b>4</b>
2.1. Vibrating level switch with PNP transistor output.....	4
2.2. Vibrating level switch with contactless electronic switch output.....	4
2.3. Vibrating level switch with IO-Link output .....	5
<hr/>	
<b>3. Materials</b>	<b>5</b>
3.1. Chemical Resistance Chart – Bürkert resistApp.....	5
3.2. Material specifications .....	6
<hr/>	
<b>4. Dimensions</b>	<b>6</b>
4.1. G ½" or NPT ½" connection .....	6
4.2. G ¾" or NPT ¾" connection .....	7
4.3. G 1" or NPT 1" connection .....	7
4.4. Clamp 2" connection .....	8
<hr/>	
<b>5. Performance specifications</b>	<b>8</b>
5.1. Temperature derating diagram .....	8
G or NPT connection .....	8
Clamp connection.....	8
<hr/>	
<b>6. Product installation</b>	<b>9</b>
6.1. Installation notes.....	9
<hr/>	
<b>7. Product operation</b>	<b>9</b>
7.1. Measuring principle .....	9
<hr/>	
<b>8. Ordering information</b>	<b>10</b>
8.1. Bürkert eShop – Easy ordering and quick delivery.....	10
8.2. Bürkert product filter .....	10
8.3. Ordering chart.....	10
8.4. Ordering chart accessories.....	11

## 1. General Technical Data

### Note:

The vibrating level switch is available with transistor (PNP) output or with contactless electronic output. The technical data depends on the vibrating level switch version. The common technical data are described in this chapter and detailed information on the specifics can be found in chapter [“2. Product versions” on page 4](#).

### Product properties

#### Material

Please make sure the device materials are compatible with the fluid you are using.

Detailed information can be found in chapter [“3.1. Chemical Resistance Chart – Bürkert resistApp” on page 5](#).

Detailed information about material specifications can be found in chapter [“3.2. Material specifications” on page 6](#)

Dimensions	Detailed information can be found in chapter <a href="#">“4. Dimensions” on page 6</a> .
Surface quality	Ra < 3.2 µm (thread) / Ra < 0.8 µm (clamp)
Measured variable	Limit level of liquids.
Operating mode	<ul style="list-style-type: none"> <li>• Min./max: changeover by electrical connection           <ul style="list-style-type: none"> <li>– Max.: max. detection or overflow protection</li> <li>– Min.: min. detection or dry run protection</li> </ul> </li> <li>• LED indication:           <ul style="list-style-type: none"> <li>– Green (voltage supply on)</li> <li>– Yellow (vibrating element covered)</li> <li>– Red (fault)</li> </ul> </li> </ul>
Weight	Approx. 250 g

### Performance data

Dynamic viscosity $\eta$	0.1... 10000 mPa.s
Density	Standard sensitivity: 0.7...2.5 g/cm <sup>3</sup> (High sensitivity: 0.5...2.5 g/cm <sup>3</sup> on request)
Flow velocity	Max. 6 m/s (with a viscosity of 10000 mPa.s)
Hysteresis	Approx. 2 mm with vertical installation
Switching delay	Approx. 500 ms (On/Off)

### Electrical data

Operating voltage	Depending on the device version Detailed information can be found in chapter <a href="#">“2. Product versions” on page 4</a> .
Power Source (not supplied)	Limited power source according to UL/EN 60950-1 standards or limited energy circuit according to UL/EN 61010-1 §9.4
Power consumption	Max. 0.5 W
Current consumption	Depending on the device version Detailed information can be found in chapter <a href="#">“2. Product versions” on page 4</a> .
Resonance frequency	Approx. 1100 Hz
Output	<ul style="list-style-type: none"> <li>• Transistor output PNP</li> <li>• Contactless electronic switch</li> <li>• Digital output in IO-Link operation</li> </ul>

### Media data

Process temperature	-40...+100 °C (-40...+212 °F) (+150 °C (+302 °F) for clamp process connection)
Process pressure	-1...64 bar/-100...6400 kPa (-14.51...+928.64 PSI)

### Process/Port connection & communication

Process connection	Thread G or NPT, ½", ¾" or 1"; clamp 2"
Electrical connection	Depending on the device version Detailed information can be found in chapter <a href="#">“2. Product versions” on page 4</a> .

### Approvals and certificates

#### Standards

Degree of protection according to IEC/EN 60529	Depending on the device version Detailed information can be found in chapter <a href="#">“2. Product versions” on page 4</a> .
Overvoltage category according to IEC 61010-1	Category III
Protection class according to IEC 61010-1	Depending on the device version Detailed information can be found in chapter <a href="#">“2. Product versions” on page 4</a> .

**Directives**

CE directives The applied standards, which verify conformity with the EU Directives, can be found on the EU Type Examination Certificate and/or the EU Declaration of conformity (if applicable).

**Environment and installation**

Ambient temperature	<ul style="list-style-type: none"> <li>Operating on the housing: -40...+70 °C (-40...+158 °F)</li> <li>Storage and transport: -40...+80 °C (-40...+176 °F)</li> </ul>
Temperature derating	Detailed information can be found in chapter <b>"6.1. Installation notes"</b> on page 9.
Relative air humidity	20...85 %, without condensation

**2. Product versions****2.1. Vibrating level switch with PNP transistor output****Electrical data**

Operating voltage	9.6...35 V DC
Load current	Max. 250 mA (output, permanently short-circuit proof)
Voltage loss	Max. 3 V DC
Switching voltage	Max. 34 V DC
Blocking current	< 10 µA

**Process/Port connection & communication**

Electrical connection	Cable plug acc. to EN 175301-803 or M12 × 1 male fixed connector
-----------------------	--

**Approvals and certificates****Standards**

Degree of protection according to IEC/ EN 60529	<ul style="list-style-type: none"> <li>IP65 with cable plug EN 175301-803 mounted and tightened</li> <li>IP66/IP67 with M12 × 1 plug mounted</li> </ul>
Protection class according to IEC 61010-1	II

**2.2. Vibrating level switch with contactless electronic switch output****Electrical data**

Operating voltage	<ul style="list-style-type: none"> <li>20...253 V AC, 50/60 Hz</li> <li>20...253 V DC</li> </ul>
Load current	<ul style="list-style-type: none"> <li>Min. 10 mA</li> <li>Max. 250 mA</li> </ul>

**Process/Port connection & communication**

Electrical connection	M12 × 1 male fixed connector
-----------------------	------------------------------

**Approvals and certificates****Standards**

Degree of protection according to IEC/ EN 60529	IP66/IP67 with M12 × 1 plug mounted
Protection class according to IEC 61010-1	I

### 2.3. Vibrating level switch with IO-Link output

Electrical data	
Operating voltage (V+)	9.6...35 V DC
Max. resistive load	$R_A \leq 0.5 \text{ k}\Omega$
Switching current	<ul style="list-style-type: none"> <li>• With IO-Link: communication (C)-Switching output 1 (Q1) noted C/Q1: 100 mA</li> <li>• Switching output 2 (Q2): 250 mA</li> </ul>
Switching voltage	$\geq$ operating voltage (V+) - 2.7 V CC
Power consumption	Max. 0.5 W
Cable	3-wire unshielded cable, max. 20 m
Process/Port connection & communication	
Electrical connection	M12 x 1 male connector

#### Digital communication: IO-Link

Communication interface	IO-Link device V1.1, downward compatible to V1.0
Baud rate (data transfer rate)	COM 3 (230.4 kBaud)
Cycle time	Min. 2 ms
IO device description (IODD)	Depending on the ordered measurement range See "Device Description Files" on the website in the Software chapter <b>Type 8110</b> ► or available at <a href="https://ioddfinder.io-link.com">https://ioddfinder.io-link.com</a>

#### Approvals and certificates

##### Standards

Degree of protection according to IEC/ EN 60529	IP66/IP67 with M12 x 1 plug mounted
Protection class according to IEC 61010-1	II

## 3. Materials

### 3.1. Chemical Resistance Chart – Bürkert resistApp



#### Bürkert resistApp – Chemical Resistance Chart

You want to ensure the reliability and durability of the materials in your individual application case? Verify your combination of media and materials on our website or in our resistApp.

[Start Chemical Resistance Check](#)

### 3.2. Material specifications

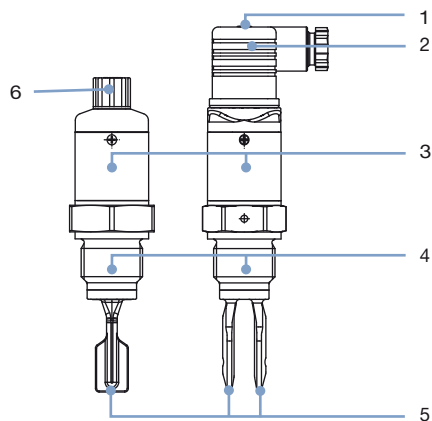

No.	Element	Material
1	Screw	Stainless steel
2	Cable plug EN175301-803	<ul style="list-style-type: none"> <li>Contact support, housing plug in PA</li> <li>Contact surface in Sn</li> <li>Plug seal in silicone</li> </ul>
3	Housing	Plastic PEI (Polyetherimide) and stainless steel 316L (1.4404)
4	Process connection	Stainless steel 316L (1.4435)
5	Tuning fork	Stainless steel 316L (1.4435)
6	Multipin M12×1 cable plug with cap	<ul style="list-style-type: none"> <li>Contact support in PA</li> <li>Contacts in CuZn, nickel layer and 0.8 µm gold-plated</li> <li>Plug seal in FKM</li> </ul>
-	Process seal (not shown)	NBR with aramid fibres

## 4. Dimensions

### 4.1. G ½" or NPT ½" connection

**Note:**

Dimensions in mm

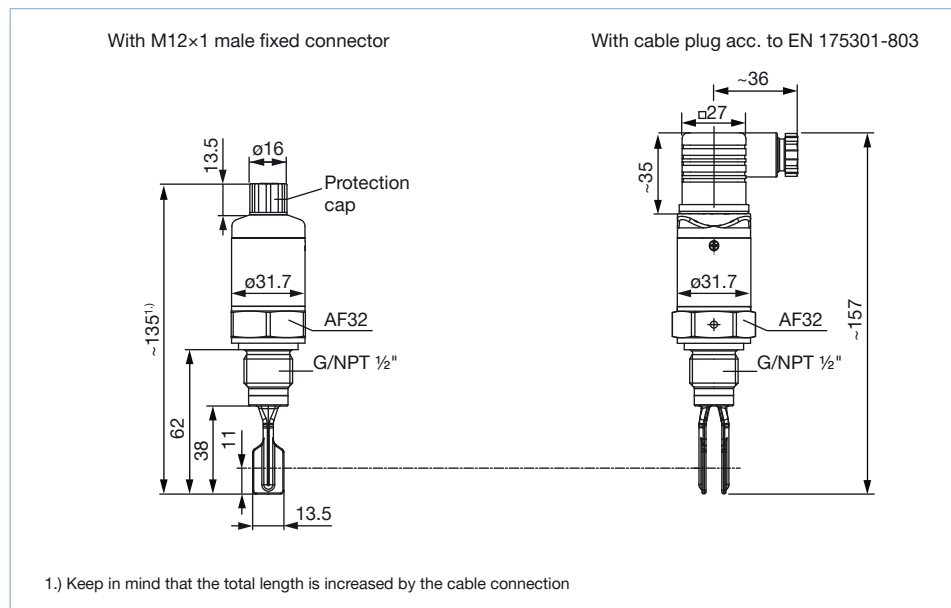

### 4.2. G 3/4" or NPT 3/4" connection

**Note:**  
Dimensions in mm

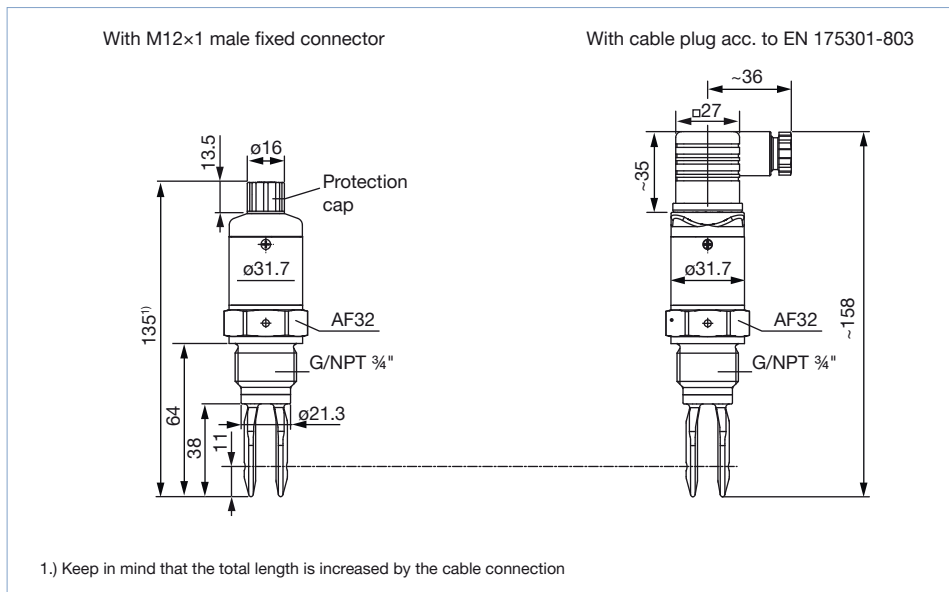

### 4.3. G 1" or NPT 1" connection

**Note:**  
Dimensions in mm

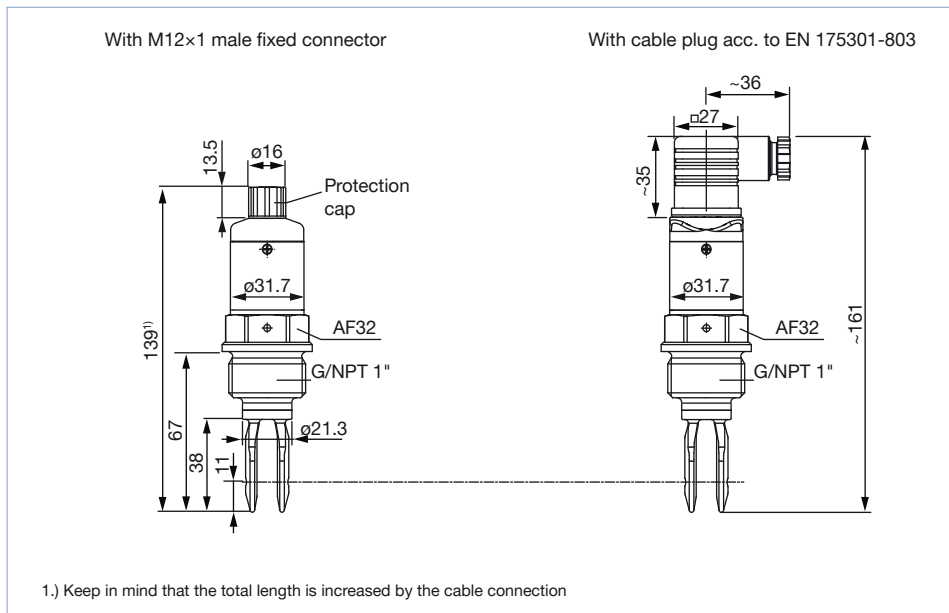

DTS 1000079485 EN Version: N Status: RL (released | freigegeben | valide) printed: 20.09.2021

#### 4.4. Clamp 2" connection

**Note:**

Dimensions in mm

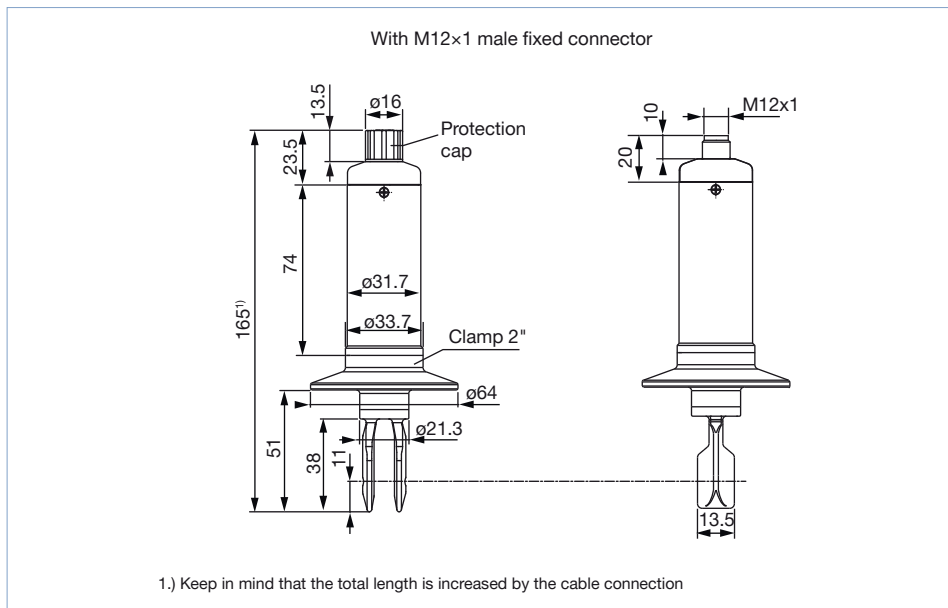

### 5. Performance specifications

#### 5.1. Temperature derating diagram

G or NPT connection

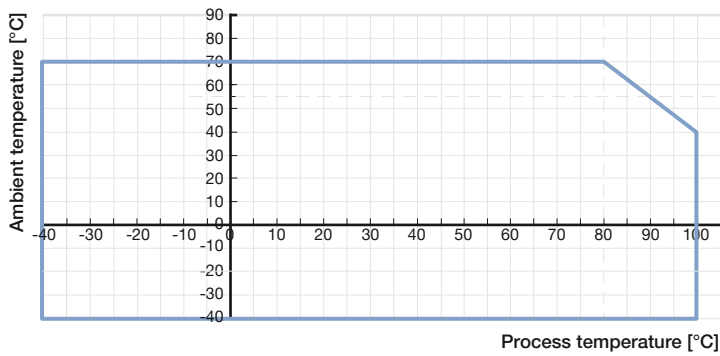

Clamp connection

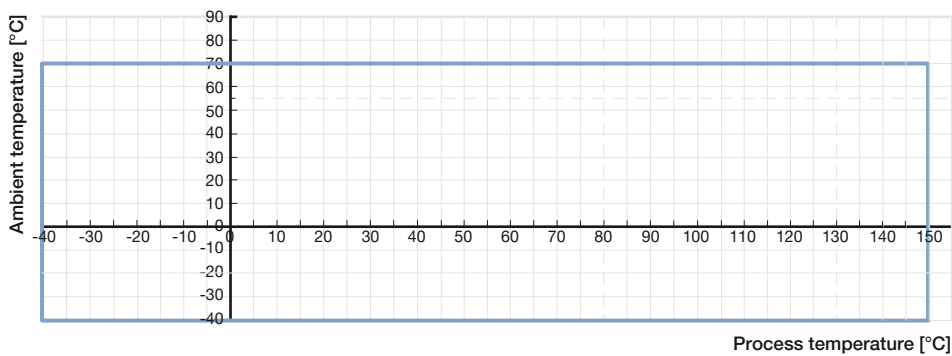



## 6. Product installation

### 6.1. Installation notes

#### Note:

- **Inflowing material:**

If the Type 8110 vibrating level switch is mounted in the filling stream, unwanted switching signals can be generated. Mount the switch at a location in the vessel where no disturbing influence from e.g. filling openings, agitators, etc. can occur.

- **Flow:**

If there is movement within the product, the tuning fork of the switch should be mounted in such a way that the surfaces of the fork are parallel to the product movement

The 8110 vibrating level switch can be installed in any position. The instrument only has to be mounted in such a way that the tuning fork is at the height of the desired switching point.

The switching point refers to the medium water ( $1 \text{ g/cm}^3/0.036 \text{ lbs/in}^3$ ). Please keep in mind that the switching point of the instrument shifts when the medium has a different density than water.

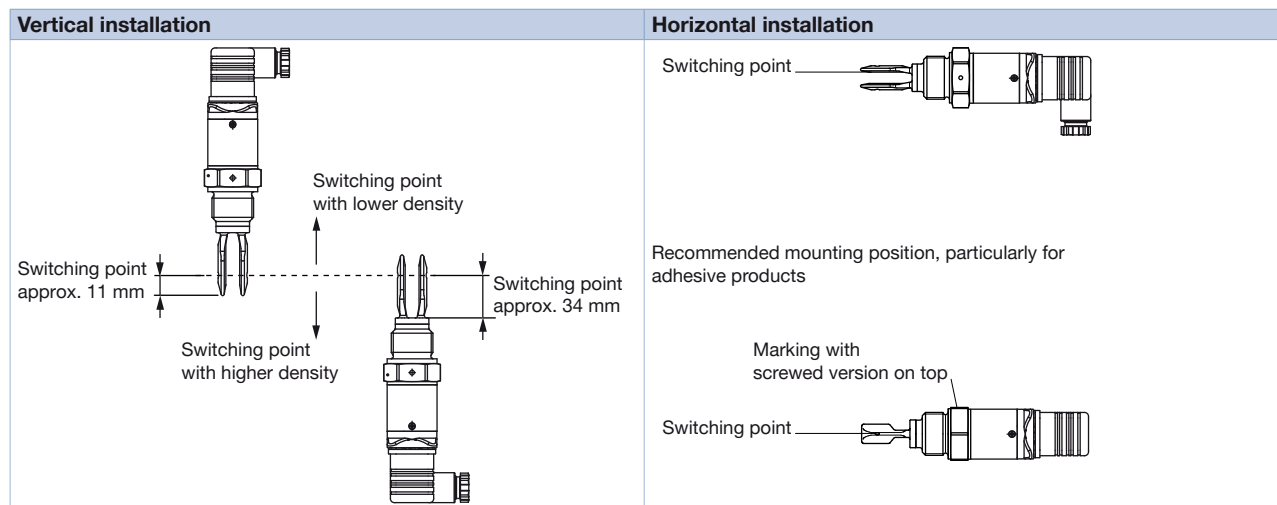

## 7. Product operation

### 7.1. Measuring principle

The tuning fork is piezoelectrically energised and vibrates at a mechanical resonance frequency of approx. 1100 Hz. When the tuning fork is submerged in the product, the frequency changes. This change is detected by the integrated oscillator and converted into a switching command.

The integrated fault monitor detects the following faults:

- Interruption of the connection cable to the piezoelectric elements
- Extreme material wear on the tuning fork
- Breakage of the tuning fork
- Absence of vibration.

If one of these faults is detected or in case the power supply fails, the electronic system switches to a defined switching state, e.g. the relay de-energises (safe state).

## 8. Ordering information

### 8.1. Bürkert eShop – Easy ordering and quick delivery



#### Bürkert eShop – Easy ordering and fast delivery

You want to find your desired Bürkert product or spare part quickly and order directly? Our online shop is available for you 24/7. Sign up and enjoy all the benefits.

[Order online now](#)

### 8.2. Bürkert product filter





















#### Bürkert product filter – Get quickly to the right product

You want to select products comfortably based on your technical requirements? Use the Bürkert product filter and find suitable articles for your application quickly and easily.



[Try out our product filter](#)

### 8.3. Ordering chart

Output	Operating voltage	Process connection	Electrical connection	Article no.
Transistor PNP	9.6...35 V DC	G ½"	Cable plug EN 175301-803	563554 
			Multipin M12 × 1	563474 
		NPT ½"	Cable plug EN 175301-803	563556 
			Multipin M12 × 1	563555 
		G ¾"	Cable plug EN 175301-803	555291 
			Multipin M12 × 1	555290 
		NPT ¾"	Cable plug EN 175301-803	560986 
			Multipin M12 × 1	557154 
Contactless electronic switching output (not with PLC)	20...253 V AC, 50/60 Hz or 20...253 V DC	G 1"	Cable plug EN 175301-803	555293 
			Multipin M12 × 1	555292 
		NPT 1"	Multipin M12 × 1	557155 
			Clamp 2"	Multipin M12 × 1
IO-Link	9.6...35 V DC	G ¾"	Cable plug EN 175301-803	555296 
				555298 
		NPT ¾"	Connecteur multibroche M12 × 1	572025 
				572026 
				572027 
Clamp 2"	572028 			

Further versions on request	
 <b>Process connection</b> <ul style="list-style-type: none"> <li>• Clamp 1"; 1½"</li> <li>• DIN 11851</li> <li>• SMS</li> </ul>	 <b>Hygienic</b> Ra < 0.8 µm for G or NPT threaded connection
 <b>Electrical connection</b> Quick on connection (IP65)	

#### 8.4. Ordering chart accessories

Description	Article no.
5 pin M12 female connector moulded on cable (2 m, shielded)	438680 
5 pin M12 female cable connector with plastic threaded locking ring	917116 

# Bürkert – Close to You

For up-to-date addresses  
please visit us at  
[www.burkert.com](http://www.burkert.com)

DTS 1000079485 EN Version: N Status: RL (released | freigegeben | validé) printed: 20.09.2021

