

Series TC08



AVENTICS™ Series TC08



Valve system, Series TC08

- Configurable valve systems



Blocking principle	Plate principle
Working pressure min./max.	-0.9 ... 10 bar
Control pressure min./max.	2.5 ... 10 bar
Ambient temperature min./max.	-10 ... 50 °C
Medium temperature min./max.	-10 ... 50 °C
Medium	Compressed air
Max. particle size	5 µm
Oil content of compressed air	0 ... 5 mg/m³
Nominal flow Qn	800 l/min
Number of valve positions max.	12
Protection class with connection	IP65
Voltage tolerance DC	-10% / +10%
Voltage tolerance AC 50 Hz	-10% / +10%
Voltage tolerance AC 60 Hz	-10% / +10%

An example configuration is illustrated. The delivered product may thus deviate from the illustration.

Overview of variants

	Version	You have the following options:
	Single plug-in wiring	Electrical connection Plug M8 plug, form C Valve plug connector

Technical information

The min. control pressure must be adhered to, since otherwise faulty switching and valve failure may result!
 The pressure dew point must be at least 15 °C under ambient and medium temperature and may not exceed 3 °C .
 The oil content of compressed air must remain constant during the life cycle.
 Use only the approved oils from AVENTICS. Further information can be found in the "Technical information" document (available in the MediaCentre).

Operational voltage for electrical port M8 (3 or 4-pin) only 24 V DC
 See the following pages on the series for technical data on individual components.
 It is necessary to maintain the electrical current in the coil of double solenoid valves to avoid unexpected auto-switching.

Technical information

Material	
End plate	Die-cast aluminum
Seal	Acrylonitrile butadiene rubber, Polyurethane
Base plate	Polyamide

Dimensions

Dimensions in mm, pneumatic subbase, right, Thread connections acc. to ISO 228-1

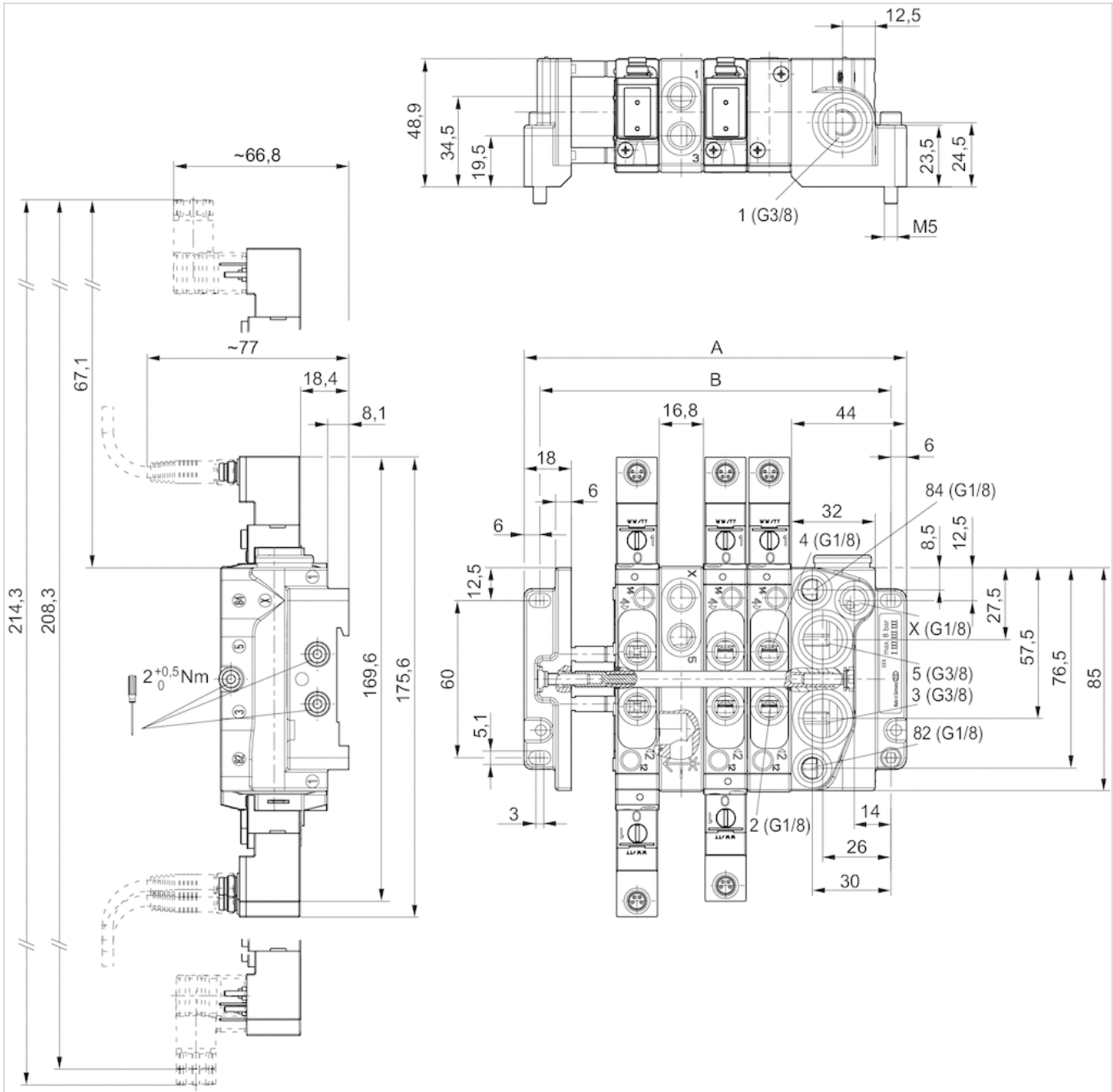

An example configuration is illustrated. The delivered product may thus deviate from the illustration.
 Mounted via 4 through-holes in the end plates or assembly on DIN rail as per EN 60715

Dimensions

n	A	B
2	95.6	83.6
3	112.4	100.4
4	129.2	117.2
5	146	134
6	162.8	150.8

n	A	B
7	179.6	167.6
8	196.4	184.4
9	213.2	201.2
10	230	218
11	246.8	234.8
12	263.6	251.6

n = number of valve positions

Dimensions

Dimensions in mm, pneumatic subbase, left, Thread connections acc. to ISO 228-1

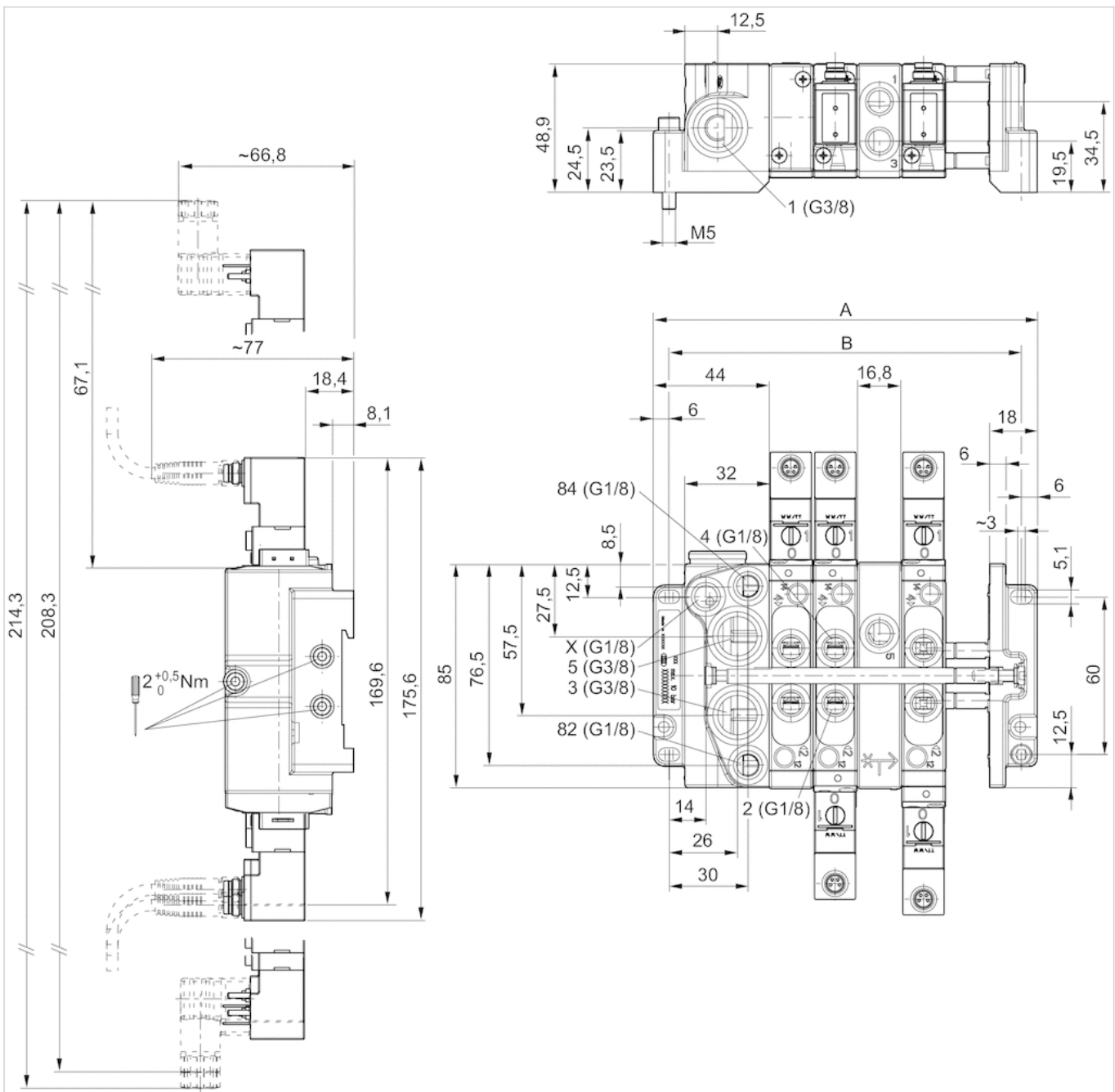

An example configuration is illustrated. The delivered product may thus deviate from the illustration.
 Mounted via 4 through-holes in the end plates or assembly on DIN rail as per EN 60715

Dimensions

n	A	B
2	95.6	83.6
3	112.4	100.4
4	129.2	117.2
5	146	134
6	162.8	150.8
7	179.6	167.6
8	196.4	184.4
9	213.2	201.2
10	230	218
11	246.8	234.8
12	263.6	251.6

n = number of valve positions

Dimensions

Dimensions in mm, pneumatic subbase on both sides, Thread connections acc. to ISO 228-1

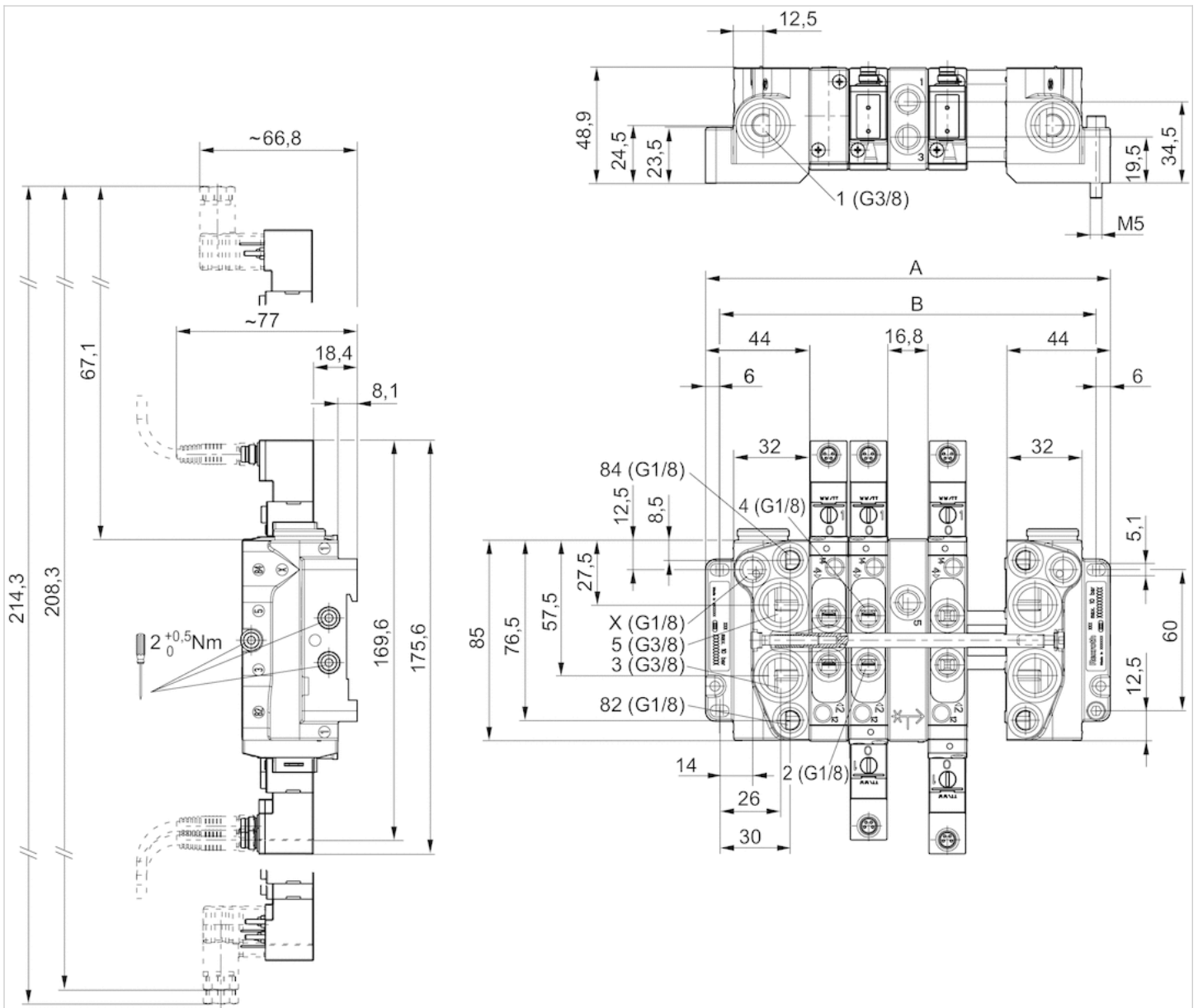

An example configuration is illustrated. The delivered product may thus deviate from the illustration.
 Mounted via 4 through-holes in the end plates or assembly on DIN rail as per EN 60715

Dimensions

n	A	B
2	121.6	109.6
3	138.4	126.4
4	155.2	143.2
5	172	160
6	188.8	176.8
7	205.6	193.6
8	222.4	210.4
9	239.2	227.2

n	A	B
10	256	244
11	272.8	260.8
12	289.6	277.6

n = number of valve positions

5/2-directional valve, Series TC08

- 5/2
- Qn = 800 l/min
- Pilot valve width : 15 mm
- Plate connection Pipe connection
- Compressed air connection output : G 1/8
- Electrical connection : Plug, M8, 3-pin
- Can be assembled into blocks
- Manual override : with detent
- single solenoid double solenoid
- Pilot : External



Version	Spool valve, positive overlapping
Activation	Electrically
Pilot	External
Sealing principle	Soft sealing
Blocking principle	Plate principle
Working pressure min./max.	-0.9 ... 10 bar
Control pressure min./max.	See table below
Ambient temperature min./max.	-10 ... 50 °C
Medium temperature min./max.	-10 ... 50 °C
Medium	Compressed air
Max. particle size	5 µm
Oil content of compressed air	0 ... 5 mg/m ³
Nominal flow Qn	800 l/min
Connector standard	DIN EN 60947-5-2
Protection class acc. to DIN EN 61140	Class III
Electrically	
Protection class with connection	IP65
LED status display	Yellow
Duty cycle	100 %
Weight	See table below

Technical data

Part No.		MO	Compressed air connection	Operational voltage
			Output	DC
R422100962			G 1/8	24 V
R422100963			G 1/8	24 V
R422100964			G 1/8	24 V

Part No.	Voltage tolerance	Power consumption	Flow conductance	Flow conductance
	DC	DC	b	C-value
R422100962	-10% / +10%	2.2 W	0.36	3.5 l/(s*bar)
R422100963	-10% / +10%	2.2 W	0.36	3.5 l/(s*bar)
R422100964	-10% / +10%	2.2 W	0.36	3.5 l/(s*bar)

Part No.	Nominal resistance	Control pressure min./max.	Typ. switch-on time	Typ. switch-off time	Weight
R422100962	280 Ω	2.5 ... 10 bar	14 ms	18 ms	0.125 kg
R422100963	280 Ω	3 ... 10 bar	14 ms	17 ms	0.125 kg
R422100964	280 Ω	2 ... 10 bar	10 ms	10 ms	0.157 kg

Nominal flow Q_n at 6 bar and $\Delta p = 1$ bar, MO = Manual override

Technical information

The min. control pressure must be adhered to, since otherwise faulty switching and valve failure may result!

The pressure dew point must be at least 15 °C under ambient and medium temperature and may not exceed 3 °C .

The oil content of compressed air must remain constant during the life cycle.

Use only the approved oils from AVENTICS. Further information can be found in the "Technical information" document (available in the MediaCentre).

Technical information

Material	
Housing	Polyamide fiber-glass reinforced
Seals	Acrylonitrile butadiene rubber Polyurethane
Front plate	Polyamide fiber-glass reinforced
Threaded bushing	Brass Die cast zinc, nickel-plated chrome-plated

Pin assignments

PIN assignment and cable colors for valve plug connectors

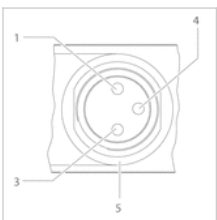

PIN assignment:

- 1) PIN not assigned
- 3) 0 V
- 4) 24 V
- 5) LED

Cable color

- 1) Brown
- 3) Blue
- 4) Black

Note: Bi-polar protective circuit to prevent overvoltage













5/2-directional valve, Series TC08

- 5/2
- Qn = 800 l/min
- Pilot valve width : 15 mm
- Plate connection Pipe connection
- Compressed air connection output : G 1/8
- Electrical connection : Plug, M8, 4-pin
- Can be assembled into blocks
- Manual override : with detent without detent
- single solenoid double solenoid
- Pilot : External



Version	Spool valve, positive overlapping
Activation	Electrically
Pilot	External
Sealing principle	Soft sealing
Blocking principle	Plate principle
Working pressure min./max.	-0.9 ... 10 bar
Control pressure min./max.	See table below
Ambient temperature min./max.	-10 ... 50 °C
Medium temperature min./max.	-10 ... 50 °C
Medium	Compressed air
Nominal flow Qn	800 l/min
Connector standard	DIN EN 60947-5-2
Protection class acc. to DIN EN 61140	Class III
Electrically	
Protection class with connection	IP65
LED status display	Yellow
Duty cycle	100 %
Weight	See table below

Technical data

Part No.		MO	Compressed air connection	Operational voltage
			Output	DC
0820060796			G 1/8	24 V
0820060797			G 1/8	24 V
0820060798			G 1/8	24 V
0820060896			G 1/8	24 V
0820060897			G 1/8	24 V
0820060898			G 1/8	24 V

Part No.	Voltage tolerance	Power consumption	Flow conductance	Flow conductance
	DC	DC	b	C-value
0820060796	-10% / +10%	2.2 W	0.36	3.5 l/(s*bar)
0820060797	-10% / +10%	2.2 W	0.36	3.5 l/(s*bar)
0820060798	-10% / +10%	2.2 W	0.36	3.5 l/(s*bar)
0820060896	-10% / +10%	2.2 W	0.36	3.5 l/(s*bar)
0820060897	-10% / +10%	2.2 W	0.36	3.5 l/(s*bar)

Part No.	Voltage tolerance	Power consumption	Flow conductance	Flow conductance
	DC	DC	b	C-value
0820060898	-10% / +10%	2.2 W	0.36	3.5 l/(s*bar)

Part No.	Nominal resistance	Control pressure min./max.	Typ. switch-on time	Typ. switch-off time	Weight
0820060796	280 Ω	2.5 ... 10 bar	14 ms	18 ms	0.125 kg
0820060797	280 Ω	3 ... 10 bar	14 ms	17 ms	0.125 kg
0820060798	280 Ω	2 ... 10 bar	10 ms	10 ms	0.157 kg
0820060896	280 Ω	2.5 ... 10 bar	14 ms	17 ms	0.125 kg
0820060897	280 Ω	3 ... 10 bar	14 ms	17 ms	0.125 kg
0820060898	280 Ω	2 ... 10 bar	10 ms	10 ms	0.157 kg

Nominal flow Q_n at 6 bar and $\Delta p = 1$ bar, MO = Manual override

Technical information

The min. control pressure must be adhered to, since otherwise faulty switching and valve failure may result!

The pressure dew point must be at least 15 °C under ambient and medium temperature and may not exceed 3 °C .

The oil content of compressed air must remain constant during the life cycle.

Use only the approved oils from AVENTICS. Further information can be found in the "Technical information" document (available in the MediaCentre).

Technical information

Material

Housing	Polyamide fiber-glass reinforced
Seals	Acrylonitrile butadiene rubber Polyurethane
Front plate	Polyamide fiber-glass reinforced
Threaded bushing	Brass Die cast zinc, nickel-plated chrome-plated

Pin assignments

PIN assignment and cable colors for valve plug connectors

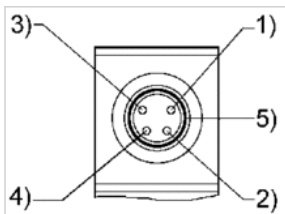

PIN assignment:

- 1) PIN not assigned
- 2) PIN not assigned
- 3) 0 V
- 4) 24 V
- 5) LED

Cable colors

- 1) Brown
- 2) White
- 3) Blue

4) Black







5/3-directional valve, Series TC08

- 5/3
- $Q_n = 700$ l/min
- Pilot valve width : 15 mm
- closed center exhausted center pressurized center
- Plate connection Pipe connection
- Compressed air connection output : G 1/8
- Electrical connection : Plug, M8, 3-pin
- Can be assembled into blocks
- Manual override : with detent
- double solenoid
- Pilot : External

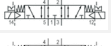

Version	Spool valve, positive overlapping
Activation	Electrically
Pilot	External
Sealing principle	Soft sealing
Blocking principle	Plate principle
Working pressure min./max.	-0.9 ... 10 bar
Control pressure min./max.	3 ... 10 bar
Ambient temperature min./max.	-10 ... 50 °C
Medium temperature min./max.	-10 ... 50 °C
Medium	Compressed air
Nominal flow Q_n	700 l/min
Connector standard	DIN EN 60947-5-2
Protection class acc. to DIN EN 61140	Class III
Electrically	
Protection class with connection	IP65
LED status display	Yellow
Duty cycle	100 %
Typ. switch-on time	10 ms
Typ. switch-off time	11 ms
Weight	0.165 kg

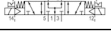
Technical data

Part No.		MO		Compressed air connection	
					Output
R422100965			closed center		G 1/8
R422100966			exhausted center		G 1/8
R422100967			pressurized center		G 1/8

Part No.	Operational voltage	Voltage tolerance	Power consumption
			DC
R422100965	24 V	-10% / +10%	2.2 W
R422100966	24 V	-10% / +10%	2.2 W
R422100967	24 V	-10% / +10%	2.2 W

Part No.	Flow conductance	Flow conductance	Nominal resistance
	b	C-value	
R422100965	0.34	3 l/(s*bar)	280 Ω
R422100966	0.34	3 l/(s*bar)	280 Ω
R422100967	0.34	3 l/(s*bar)	280 Ω

Nominal flow Q_n at 6 bar and $\Delta p = 1$ bar, MO = Manual override

Technical information

The min. control pressure must be adhered to, since otherwise faulty switching and valve failure may result!

The pressure dew point must be at least 15 °C under ambient and medium temperature and may not exceed 3 °C .

The oil content of compressed air must remain constant during the life cycle.

Use only the approved oils from AVENTICS. Further information can be found in the "Technical information" document (available in the MediaCentre).

Technical information

Material	
Housing	Polyamide fiber-glass reinforced
Seals	Acrylonitrile butadiene rubber Polyurethane
Front plate	Polyamide fiber-glass reinforced
Threaded bushing	Brass Die cast zinc, nickel-plated chrome-plated

Pin assignments

PIN assignment and cable colors for valve plug connectors

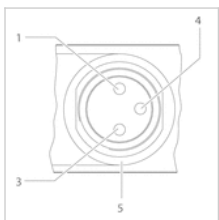

PIN assignment:

- 1) PIN not assigned
- 3) 0 V
- 4) 24 V
- 5) LED

Cable color

- 1) Brown
- 3) Blue
- 4) Black

Note: Bi-polar protective circuit to prevent overvoltage

5/3-directional valve, Series TC08

- 5/3
- Qn = 700 l/min
- Pilot valve width : 15 mm
- closed center exhausted center pressurized center
- Plate connection Pipe connection
- Compressed air connection output : G 1/8
- Electrical connection : Plug, M8, 4-pin
- Can be assembled into blocks
- Manual override : with detent without detent
- double solenoid
- Pilot : External



Version	Spool valve, positive overlapping
Activation	Electrically
Pilot	External
Sealing principle	Soft sealing
Blocking principle	Plate principle
Working pressure min./max.	-0.9 ... 10 bar
Control pressure min./max.	3 ... 10 bar
Ambient temperature min./max.	-10 ... 50 °C
Medium temperature min./max.	-10 ... 50 °C
Medium	Compressed air
Max. particle size	5 µm
Oil content of compressed air	0 ... 5 mg/m ³
Nominal flow Qn	700 l/min
Connector standard	DIN EN 60947-5-2
Protection class acc. to DIN EN 61140 Electrically	Class III
Protection class with connection	IP65
LED status display	Yellow
Duty cycle	100 %
Typ. switch-on time	10 ms
Typ. switch-off time	11 ms
Weight	0.165 kg

Technical data

Part No.	MO	Compressed air connection	
			Output
0820061796		closed center	G 1/8
0820061797		exhausted center	G 1/8
0820061798		pressurized center	G 1/8
0820061896		closed center	G 1/8
0820061897		exhausted center	G 1/8
0820061898		pressurized center	G 1/8

Part No.	Operational voltage	Voltage tolerance	Power consumption
		DC	DC

Part No.	Operational voltage	Voltage tolerance	Power consumption
	DC	DC	DC
0820061796	24 V	-10% / +10%	2.2 W
0820061797	24 V	-10% / +10%	2.2 W
0820061798	24 V	-10% / +10%	2.2 W
0820061896	24 V	-10% / +10%	2.2 W
0820061897	24 V	-10% / +10%	2.2 W
0820061898	24 V	-10% / +10%	2.2 W

Part No.	Flow conductance	Flow conductance	Nominal resistance
	b	C-value	
0820061796	0.34	3 l/(s*bar)	280 Ω
0820061797	0.34	3 l/(s*bar)	280 Ω
0820061798	0.34	3 l/(s*bar)	280 Ω
0820061896	0.34	3 l/(s*bar)	280 Ω
0820061897	0.34	3 l/(s*bar)	280 Ω
0820061898	0.34	3 l/(s*bar)	280 Ω

Nominal flow Qn at 6 bar and Δp = 1 bar, MO = Manual override

Technical information

The min. control pressure must be adhered to, since otherwise faulty switching and valve failure may result!
 The pressure dew point must be at least 15 °C under ambient and medium temperature and may not exceed 3 °C .
 The oil content of compressed air must remain constant during the life cycle.
 Use only the approved oils from AVENTICS. Further information can be found in the “Technical information” document (available in the MediaCentre).

Technical information

Material	
Housing	Polyamide fiber-glass reinforced
Seals	Acrylonitrile butadiene rubber Polyurethane
Front plate	Polyamide fiber-glass reinforced
Threaded bushing	Brass Die cast zinc, nickel-plated chrome-plated

Pin assignments

PIN assignment and cable colors for valve plug connectors

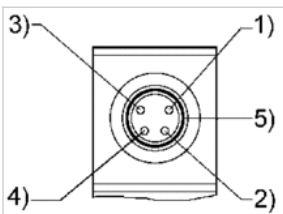

PIN assignment:
 1) PIN not assigned
 2) PIN not assigned

- 3) 0 V
 - 4) 24 V
 - 5) LED
- Cable colors
- 1) Brown
 - 2) White
 - 3) Blue
 - 4) Black













2x3/2-directional valve, Series TC08

- Operating voltage 24 V DC
- 2x3/2
- Qn = 600 l/min
- Pilot valve width : 15 mm
- NC/NC NO/NO NC/NO
- Plate connection Pipe connection
- Compressed air connection output : G 1/8
- Electrical connection : Plug, ISO 15217, form C
- Can be assembled into blocks
- Manual override : with detent, without detent without detent
- double solenoid
- Pilot : External



Version	Spool valve, positive overlapping
Activation	Electrically
Pilot	External
Sealing principle	Soft sealing
Blocking principle	Plate principle
Working pressure min./max.	-0.9 ... 10 bar
Control pressure min./max.	2.5 ... 10 bar
Ambient temperature min./max.	-10 ... 50 °C
Medium temperature min./max.	-10 ... 50 °C
Medium	Compressed air
Max. particle size	5 µm
Oil content of compressed air	0 ... 5 mg/m ³
Nominal flow Qn	600 l/min
Connector standard	ISO 15217
Protection class with connection	IP65
Duty cycle	100 %
Generic emission standard in accordance with	EN 50081-2:1993
Mounting screw tightening torque	2 Nm
Weight	0.166 kg

Technical data

Part No.		MO		Compressed air connection	
				Input	
R422102062			NC/NC	G 1/8	
R422102066			NO/NO	G 1/8	
R422102070			NC/NO	G 1/8	
R422102074			NC/NC	G 1/8	
R422102078			NO/NO	G 1/8	
R422102082			NC/NO	G 1/8	

Part No.	Compressed air connection	
	Output	Exhaust
R422102062	G 1/8	G 1/8
R422102066	G 1/8	G 1/8

Part No.	Compressed air connection	
	Output	Exhaust
R422102070	G 1/8	G 1/8
R422102074	G 1/8	G 1/8
R422102078	G 1/8	G 1/8
R422102082	G 1/8	G 1/8

Part No.	Operational voltage	Voltage tolerance	Power consumption	Nominal resistance
	DC	DC	DC	
R422102062	24 V	-10% / +10%	2 W	280 Ω
R422102066	24 V	-10% / +10%	2 W	280 Ω
R422102070	24 V	-10% / +10%	2 W	280 Ω
R422102074	24 V	-10% / +10%	2 W	280 Ω
R422102078	24 V	-10% / +10%	2 W	280 Ω
R422102082	24 V	-10% / +10%	2 W	280 Ω

Nominal flow Q_n at 6 bar and $\Delta p = 1$ bar

Technical information

The min. control pressure must be adhered to, since otherwise faulty switching and valve failure may result!

The pressure dew point must be at least 15 °C under ambient and medium temperature and may not exceed 3 °C .

The oil content of compressed air must remain constant during the life cycle.

Use only the approved oils from AVENTICS. Further information can be found in the "Technical information" document (available in the MediaCentre).

Technical information

Material	
Housing	Polyamide fiber-glass reinforced
Seals	Acrylonitrile butadiene rubber Polyurethane
Front plate	Polyamide fiber-glass reinforced
Threaded bushing	Brass Die cast zinc, nickel-plated chrome-plated









5/2-directional valve, Series TC08

- Operating voltage 24 V DC
- 5/2
- Qn = 800 l/min
- Pilot valve width : 15 mm
- Plate connection Pipe connection
- Compressed air connection output : G 1/8
- Electrical connection : Plug, ISO 15217, form C
- Can be assembled into blocks
- Manual override : with detent without detent
- single solenoid double solenoid
- Pilot : External



Version	Spool valve, positive overlapping
Activation	Electrically
Pilot	External
Sealing principle	Soft sealing
Blocking principle	Plate principle
Working pressure min./max.	-0.9 ... 10 bar
Control pressure min./max.	See table below
Ambient temperature min./max.	-10 ... 50 °C
Medium temperature min./max.	-10 ... 50 °C
Medium	Compressed air
Max. particle size	5 µm
Nominal flow Qn	800 l/min
Connector standard	ISO 15217
Protection class with connection	IP65
Duty cycle	100 %
Mounting screw tightening torque	2 Nm
Weight	See table below

Technical data

Part No.	MO	Compressed air connection	
		Input	Output
0820060751		G 1/8	G 1/8
0820060761		G 1/8	G 1/8
0820060771		G 1/8	G 1/8
0820060851		G 1/8	G 1/8
R422103043		G 1/8	G 1/8
0820060861		G 1/8	G 1/8
0820060871		G 1/8	G 1/8
R422103044		G 1/8	G 1/8

Part No.	Operational voltage	Voltage tolerance	Power consumption	Nominal resistance
0820060751	24 V	-10% / +10%	2 W	280 Ω
0820060761	24 V	-10% / +10%	2 W	280 Ω
0820060771	24 V	-10% / +10%	2 W	280 Ω

Part No.	Operational voltage	Voltage tolerance	Power consumption	Nominal resistance
		DC	DC	
0820060851	24 V	-10% / +10%	2 W	280 Ω
R422103043	-	-	-	-
0820060861	24 V	-10% / +10%	2 W	280 Ω
0820060871	24 V	-10% / +10%	2 W	280 Ω
R422103044	-	-	-	-

Part No.	Control pressure min./max.	Typ. switch-on time	Typ. switch-off time
0820060751	2.5 ... 10 bar	14 ms	18 ms
0820060761	3 ... 10 bar	14 ms	17 ms
0820060771	2 ... 10 bar	10 ms	10 ms
0820060851	2.5 ... 10 bar	14 ms	18 ms
R422103043	3 ... 10 bar	14 ms	17 ms
0820060861	3 ... 10 bar	14 ms	17 ms
0820060871	2 ... 10 bar	10 ms	10 ms
R422103044	2 ... 10 bar	10 ms	10 ms

Part No.	basic valve with electrical connector	Weight
0820060751	-	0.125 kg
0820060761	-	0.125 kg
0820060771	-	0.157 kg
0820060851	-	0.125 kg
R422103043	Basic valve without coil	0.125 kg
0820060861	-	0.125 kg
0820060871	-	0.157 kg
R422103044	Basic valve without coil	0.157 kg

Nominal flow Qn at 6 bar and $\Delta p = 1$ bar, MO = Manual override

Technical information

The min. control pressure must be adhered to, since otherwise faulty switching and valve failure may result!

The pressure dew point must be at least 15 °C under ambient and medium temperature and may not exceed 3 °C .

The oil content of compressed air must remain constant during the life cycle.

Use only the approved oils from AVENTICS. Further information can be found in the "Technical information" document (available in the MediaCentre).

Technical information

Material	
Housing	Polyamide fiber-glass reinforced
Seals	Acrylonitrile butadiene rubber Polyurethane
Front plate	Polyamide fiber-glass reinforced

Dimensions

Dimensions, single solenoid

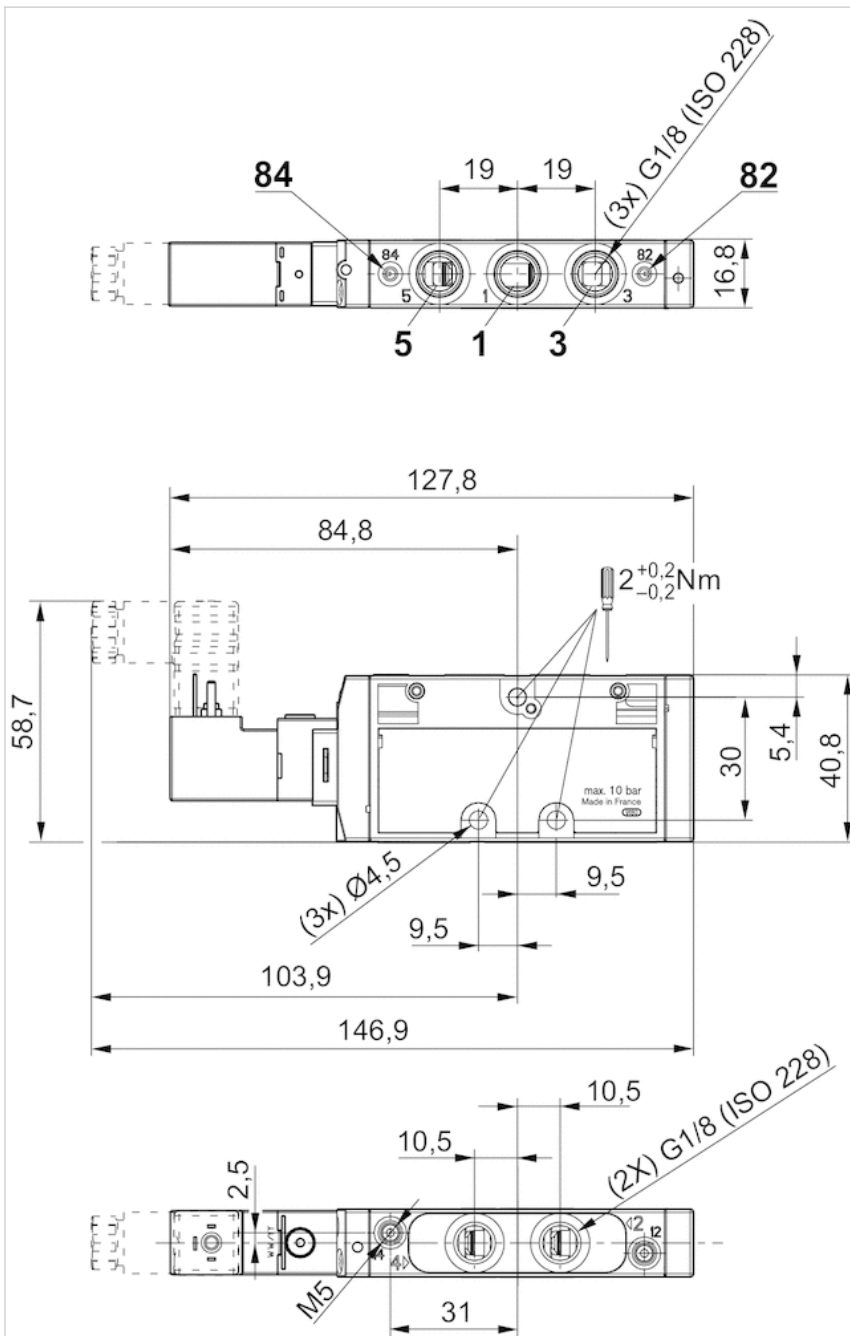















5/3-directional valve, Series TC08

- Operating voltage 24 V DC
- 5/3
- Qn = 700 l/min
- Pilot valve width : 15 mm
- closed center exhausted center pressurized center
- Plate connection Pipe connection
- Compressed air connection output : G 1/8
- Electrical connection : Plug, ISO 15217, form C
- Can be assembled into blocks
- Manual override : with detent without detent
- double solenoid
- Pilot : External

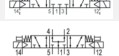

Version	Spool valve, positive overlapping
Activation	Electrically
Pilot	External
Sealing principle	Soft sealing
Blocking principle	Plate principle
Working pressure min./max.	-0.9 ... 10 bar
Control pressure min./max.	3 ... 10 bar
Ambient temperature min./max.	-10 ... 50 °C
Medium temperature min./max.	-10 ... 50 °C
Medium	Compressed air
Nominal flow Qn	700 l/min
Connector standard	ISO 15217
Protection class with connection	IP65
Duty cycle	100 %
Typ. switch-on time	10 ms
Typ. switch-off time	11 ms
Weight	0.165 kg

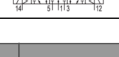
Technical data

Part No.		MO		Compressed air connection	
					Output
0820061751			closed center		G 1/8
0820061761			exhausted center		G 1/8
0820061771			pressurized center		G 1/8
0820061851			closed center		G 1/8
0820061861			exhausted center		G 1/8
R422103045			closed center		G 1/8
0820061871			pressurized center		G 1/8

Part No.	Operational voltage	Voltage tolerance		Power consumption	
		DC	DC	DC	DC
0820061751	24 V	-10% / +10%		2 W	
0820061761	24 V	-10% / +10%		2 W	
0820061771	24 V	-10% / +10%		2 W	

Part No.	Operational voltage	Voltage tolerance	Power consumption
	DC	DC	DC
0820061851	24 V	-10% / +10%	2 W
0820061861	24 V	-10% / +10%	2 W
R422103045	-	-	-
0820061871	24 V	-10% / +10%	2 W

Part No.	Flow conductance	Flow conductance	Nominal resistance	basic valve with electrical connector
	b	C-value		
0820061751	0.34	3 l/(s*bar)	280 Ω	-
0820061761	0.34	3 l/(s*bar)	280 Ω	-
0820061771	0.34	3 l/(s*bar)	280 Ω	-
0820061851	0.34	3 l/(s*bar)	280 Ω	-
0820061861	0.34	3 l/(s*bar)	280 Ω	-
R422103045	0.34	3 l/(s*bar)	-	Basic valve without coil
0820061871	0.34	3 l/(s*bar)	280 Ω	-

Nominal flow Qn at 6 bar and $\Delta p = 1$ bar

Technical information

The min. control pressure must be adhered to, since otherwise faulty switching and valve failure may result!

The pressure dew point must be at least 15 °C under ambient and medium temperature and may not exceed 3 °C .

The oil content of compressed air must remain constant during the life cycle.

Use only the approved oils from AVENTICS. Further information can be found in the "Technical information" document (available in the MediaCentre).

Technical information

Material	
Housing	Polyamide fiber-glass reinforced
Seals	Acrylonitrile butadiene rubber Polyurethane
Front plate	Polyamide fiber-glass reinforced
Threaded bushing	Brass Die cast zinc, nickel-plated chrome-plated

Dimensions

Dimensions

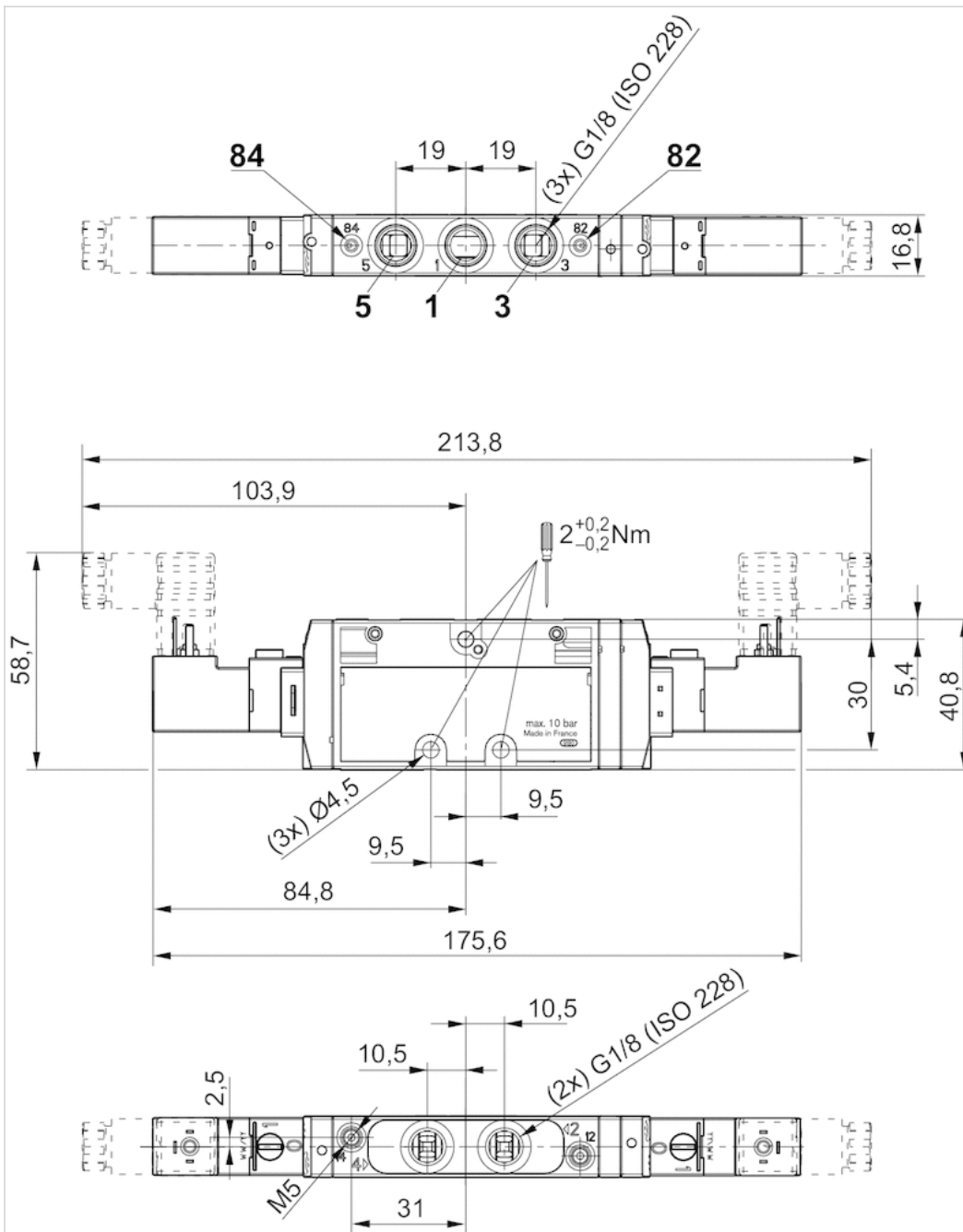







2x3/2-directional valve, Series TC08 - inch

- Operating voltage 24 V DC
- 2x3/2
- Qn = 600 l/min
- Pilot valve width : 15 mm
- NC/NC NO/NO NC/NO
- Plate connection Pipe connection
- Compressed air connection output : 1/8-27 NPTF
- Electrical connection : Plug, ISO 15217, form C
- Can be assembled into blocks
- Manual override : with detent
- double solenoid
- With spring return
- Pilot : External



Version	Spool valve, positive overlapping
Activation	Electrically
Pilot	External
Sealing principle	Soft sealing
Blocking principle	Plate principle
Working pressure min./max.	-0.9 ... 10 bar
Control pressure min./max.	2.5 ... 10 bar
Ambient temperature min./max.	-10 ... 50 °C
Medium temperature min./max.	-10 ... 50 °C
Medium	Compressed air
Max. particle size	5 µm
Oil content of compressed air	0 ... 5 mg/m ³
Nominal flow Qn	600 l/min
Connector standard	ISO 15217
Protection class with connection	IP65
Duty cycle	100 %
Typ. switch-on time	10 ms
Typ. switch-off time	14 ms
Generic emission standard in accordance with	EN 50081-2:1993
Generic immunity standard in accordance with	EN 50082-2
Mounting screw tightening torque	2.5 Nm
Weight	0.166 kg

Technical data

Part No.		MO		Compressed air connection	Operational voltage
				Output	DC
R422102125			NC/NC	1/8-27 NPTF	24 V
R422102129			NO/NO	1/8-27 NPTF	24 V
R422102133			NC/NO	1/8-27 NPTF	24 V

Part No.	Voltage tolerance	Power consumption	Flow conductance	Flow conductance
	DC	DC	b	C-value
R422102125	-10% / +10%	2 W	0.27	2.8 l/(s*bar)
R422102129	-10% / +10%	2 W	0.27	2.8 l/(s*bar)
R422102133	-10% / +10%	2 W	0.27	2.8 l/(s*bar)

Part No.	Nominal resistance
R422102125	280 Ω
R422102129	280 Ω
R422102133	280 Ω

Nominal flow Q_n at 6 bar and $\Delta p = 1$ bar, MO = Manual override

Technical information

The min. control pressure must be adhered to, since otherwise faulty switching and valve failure may result!

The pressure dew point must be at least 15 °C under ambient and medium temperature and may not exceed 3 °C .

The oil content of compressed air must remain constant during the life cycle.

Use only the approved oils from AVENTICS. Further information can be found in the "Technical information" document (available in the MediaCentre).

Technical information

Material	
Housing	Polyamide fiber-glass reinforced
Seals	Acrylonitrile butadiene rubber Polyurethane
Front plate	Polyamide fiber-glass reinforced
Threaded bushing	Brass Die cast zinc, nickel-plated chrome-plated

Dimensions

Dimensions

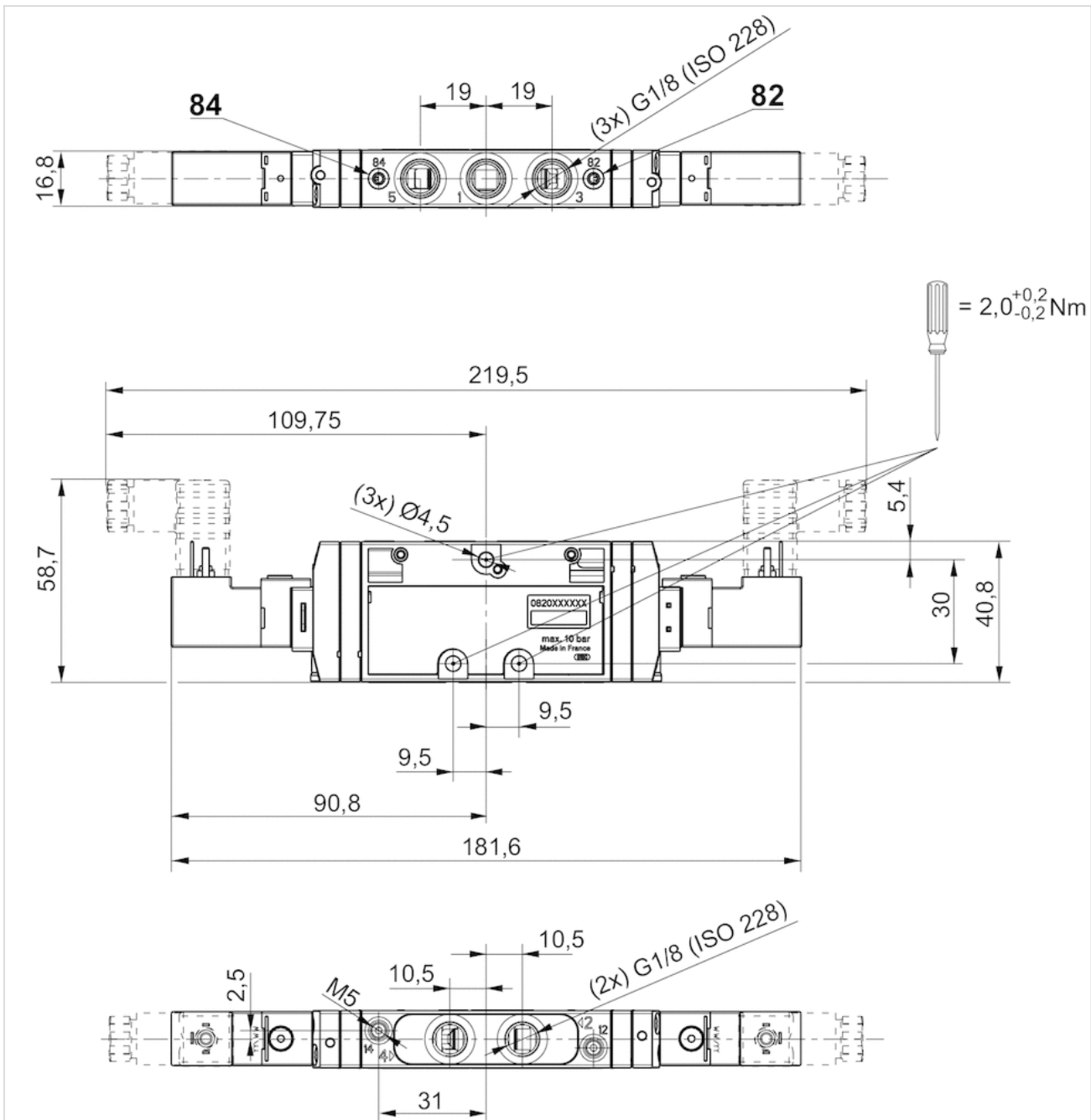

Pin assignments

PIN assignment and cable colors for valve plug connectors

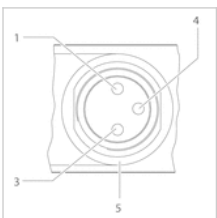

PIN assignment:
1) PIN not assigned

- 3) 0 V
- 4) 24 V
- 5) LED

Cable color

- 1) Brown
- 3) Blue
- 4) Black

Note: Bi-polar protective circuit to prevent overvoltage







5/2-directional valve, Series TC08 - inch

- Operating voltage 24 V DC
- 5/2-directional valve with air spring return
- $Q_n = 800$ l/min
- Pilot valve width : 15 mm
- Plate connection Pipe connection
- Compressed air connection output : 1/8-27 NPTF
- Electrical connection : Plug, ISO 15217, form C
- Can be assembled into blocks
- Manual override : with detent
- single solenoid
- With air spring return
- Pilot : External



Version	Spool valve, positive overlapping
Activation	Electrically
Pilot	External
Sealing principle	Soft sealing
Blocking principle	Plate principle
Working pressure min./max.	-0.9 ... 10 bar
Control pressure min./max.	See table below
Ambient temperature min./max.	-10 ... 50 °C
Medium temperature min./max.	-10 ... 50 °C
Medium	Compressed air
Max. particle size	5 µm
Oil content of compressed air	0 ... 1 mg/m ³
Nominal flow Q_n	800 l/min
Compressed air connection	according to ANSI B1.20.3
Connector standard	ISO 15217
Protection class with connection	IP65
Duty cycle	100 %
Generic emission standard in accordance with	EN 50081:1992
Weight	0.125 kg

Technical data

Part No.		MO	Compressed air connection	Operational voltage
			Output	DC
R422101153			1/8-27 NPTF	24 V
R422101157			1/8-27 NPTF	24 V
R422101161			1/8-27 NPTF	24 V

Part No.	Voltage tolerance	Power consumption	Flow conductance	Flow conductance
	DC	DC	b	C-value
R422101153	-10% / +10%	2 W	0.36	3.5 l/(s*bar)
R422101157	-10% / +10%	2 W	0.36	3.5 l/(s*bar)
R422101161	-10% / +10%	2 W	0.36	3.5 l/(s*bar)

Part No.	Nominal resistance	Control pressure min./max.	Typ. switch-on time	Typ. switch-off time
R422101153	185 Ω	2.5 ... 10 bar	14 ms	18 ms
R422101157	185 Ω	3 ... 10 bar	14 ms	17 ms
R422101161	185 Ω	2 ... 10 bar	10 ms	10 ms

Nominal flow Q_n at 6 bar and $\Delta p = 1$ bar, MO = Manual override

Technical information

The min. control pressure must be adhered to, since otherwise faulty switching and valve failure may result!

The pressure dew point must be at least 15 °C under ambient and medium temperature and may not exceed 3 °C .

The oil content of compressed air must remain constant during the life cycle.

Use only the approved oils from AVENTICS. Further information can be found in the "Technical information" document (available in the MediaCentre).

Technical information

Material	
Housing	Polyamide fiber-glass reinforced
Seals	Acrylonitrile butadiene rubber Polyurethane
Front plate	Polyamide fiber-glass reinforced
Threaded bushing	Brass Die cast zinc, nickel-plated chrome-plated

Dimensions

Dimensions, single solenoid

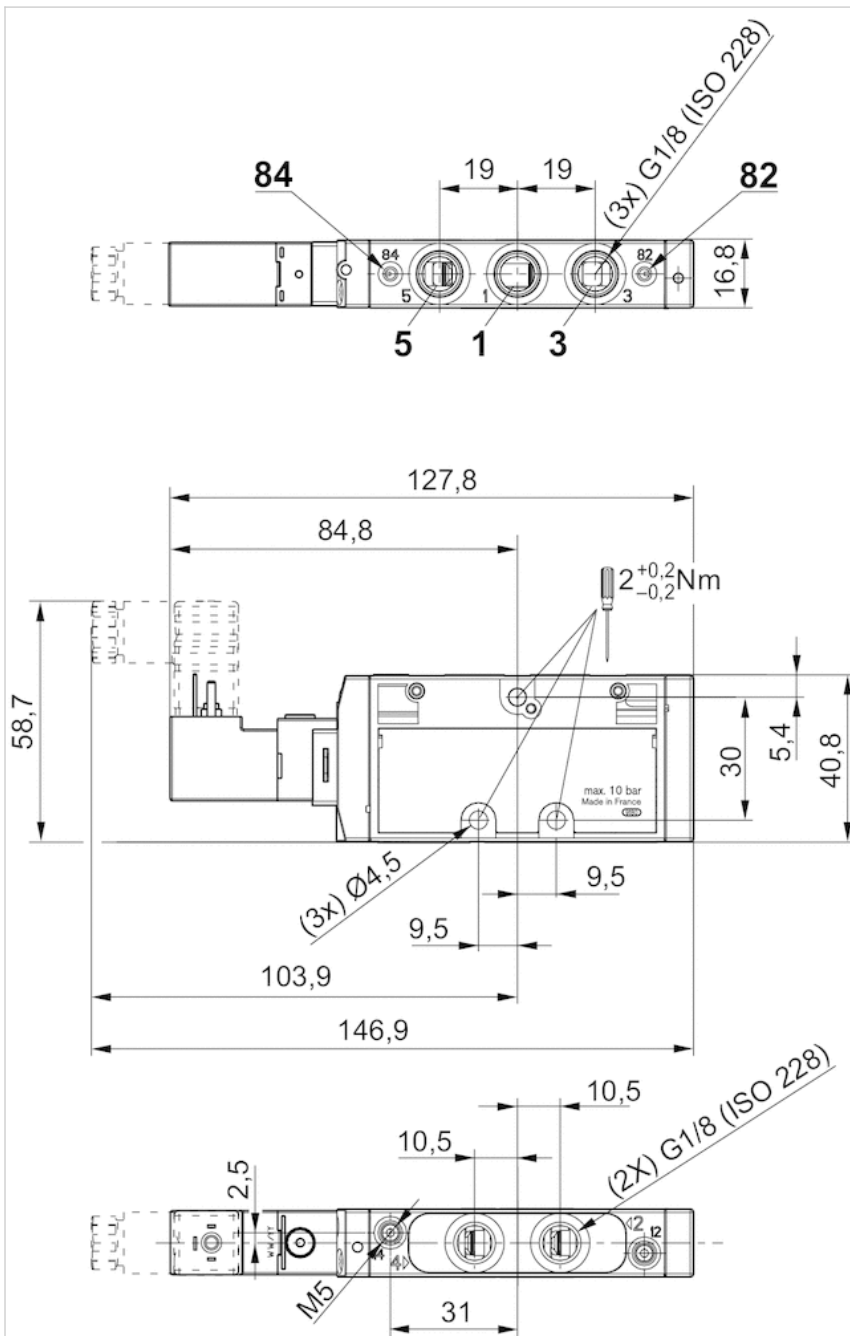







5/3-directional valve, Series TC08 - inch

- Operating voltage 24 V DC
- 5/2-directional valve with air spring return
- $Q_n = 800$ l/min
- Pilot valve width : 15 mm
- Plate connection Pipe connection
- Compressed air connection output : 1/8-27 NPTF
- Electrical connection : Plug, ISO 15217, form C
- Can be assembled into blocks
- Manual override : with detent
- single solenoid
- With air spring return
- Pilot : External

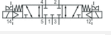

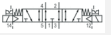
Version	Spool valve, positive overlapping
Activation	Electrically
Pilot	External
Sealing principle	Soft sealing
Blocking principle	Plate principle
Working pressure min./max.	-0.9 ... 10 bar
Control pressure min./max.	3 ... 10 bar
Ambient temperature min./max.	-10 ... 50 °C
Medium temperature min./max.	-10 ... 50 °C
Medium	Compressed air
Max. particle size	5 µm
Oil content of compressed air	0 ... 1 mg/m ³
Nominal flow Q_n	800 l/min
Compressed air connection	according to ANSI B1.20.3
Connector standard	ISO 15217
Protection class with connection	IP65
Duty cycle	100 %
Typ. switch-on time	10 ms
Typ. switch-off time	11 ms
Generic emission standard in accordance with	EN 50081:1992
Mounting screw tightening torque	2.5 Nm
Weight	0.125 kg

Technical data

Part No.		MO	Compressed air connection	Operational voltage
			Output	DC
R422101165			1/8-27 NPTF	24 V
R422101169			1/8-27 NPTF	24 V
R422101173			1/8-27 NPTF	24 V

Part No.	Voltage tolerance	Power consumption	Flow conductance	Flow conductance
	DC	DC	b	C-value
R422101165	-10% / +10%	2 W	0.36	3.5 l/(s*bar)
R422101169	-10% / +10%	2 W	0.36	3.5 l/(s*bar)
R422101173	-10% / +10%	2 W	0.36	3.5 l/(s*bar)

Part No.	Nominal resistance
R422101165	185 Ω
R422101169	185 Ω
R422101173	185 Ω

Nominal flow Q_n at 6 bar and $\Delta p = 1$ bar, MO = Manual override

Technical information

The min. control pressure must be adhered to, since otherwise faulty switching and valve failure may result!

The pressure dew point must be at least 15 °C under ambient and medium temperature and may not exceed 3 °C .

The oil content of compressed air must remain constant during the life cycle.

Use only the approved oils from AVENTICS. Further information can be found in the "Technical information" document (available in the MediaCentre).

Technical information

Material	
Housing	Polyamide fiber-glass reinforced
Seals	Acrylonitrile butadiene rubber Polyurethane
Front plate	Polyamide fiber-glass reinforced
Threaded bushing	Brass Die cast zinc, nickel-plated chrome-plated



2x3/2-directional valve, Series TC08

- Qn = 600 l/min
- Compressed air connection output G 1/8
- Plate connection Pipe connection



Version	Spool valve
Activation	pneumatically
Pilot	External
Sealing principle	Soft sealing
Blocking principle	Plate principle
Flow rate value Qn	600 l/min
Working pressure min./max.	-0.9 ... 10 bar
Control pressure min./max.	2.5 ... 10 bar
Ambient temperature min./max.	-10 ... 50 °C
Medium temperature min./max.	-10 ... 50 °C
Medium	Compressed air
Max. particle size	5 µm
Oil content of compressed air	0 ... 5 mg/m ³
Mounting screw tightening torque	2 Nm
Weight	0.098 kg

Technical data

Part No.			Compressed air connection	Compressed air connection
			Output	Pilot control exhaust
R422102097		NC/NC	G 1/8	M5
R422102098		NO/NO	G 1/8	M5
R422102099		NC/NO	G 1/8	M5

Part No.	Flow conductance	Flow conductance
	b	C-value
R422102097	0.27	2.8 l/(s*bar)
R422102098	0.27	2.8 l/(s*bar)
R422102099	0.27	2.8 l/(s*bar)

Nominal flow Qn at 6 bar and $\Delta p = 1$ bar

Technical information

The min. control pressure must be adhered to, since otherwise faulty switching and valve failure may result!

The pressure dew point must be at least 15 °C under ambient and medium temperature and may not exceed 3 °C .

The oil content of compressed air must remain constant during the life cycle.

Use only the approved oils from AVENTICS. Further information can be found in the "Technical information" document (available in the MediaCentre).

Caution: The minimum control pressure depends on the working pressure (see "Control pressure" diagram below).

Technical information

Material	
Housing	Polyamide fiber-glass reinforced
Seals	Acrylonitrile butadiene rubber
Front plate	Polyamide fiber-glass reinforced
Threaded bushing	Brass Die cast zinc, chrome-plated nickel-plated

Diagrams

Control pressure

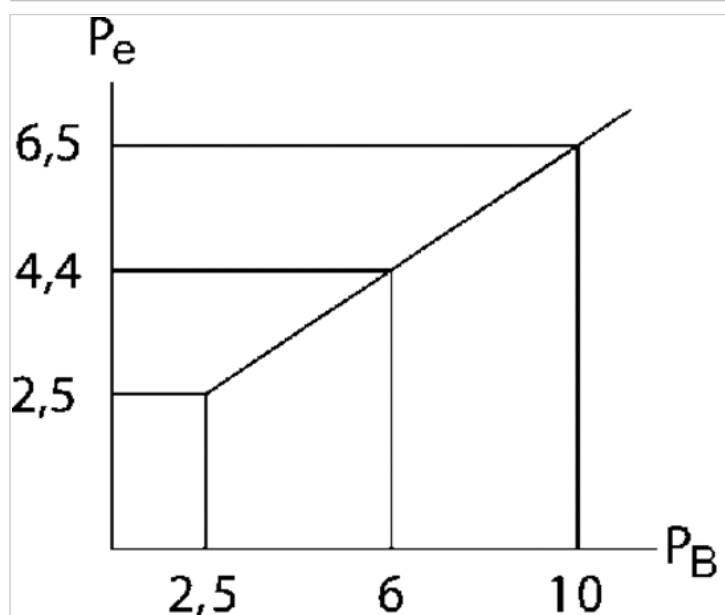

P_e = external control pressure, min.

P_B = Working pressure





5/2-directional valve, Series TC08

- Qn = 800 l/min
- Compressed air connection output G 1/8
- Plate connection Pipe connection



Version	Spool valve, positive overlapping
Activation	pneumatically
Pilot	External
Sealing principle	Soft sealing
Blocking principle	Plate principle
Flow rate value Qn	800 l/min
Working pressure min./max.	See table below
Control pressure min./max.	See table below
Ambient temperature min./max.	-10 ... 50 °C
Medium temperature min./max.	-10 ... 50 °C
Medium	Compressed air
Max. particle size	5 µm
Oil content of compressed air	0 ... 5 mg/m ³
Mounting on manifold strip	P-strip
Mounting screw tightening torque	2 Nm
Weight	0.09 kg

Technical data

Part No.		Compressed air connection	
		Input	Output
0820260701		G 1/8	G 1/8
0820260702		G 1/8	G 1/8
0820260703		G 1/8	G 1/8
0820260704		G 1/8	G 1/8

Part No.	Compressed air connection		Flow conductance b
	Exhaust	Pilot control exhaust	
0820260701	G 1/8	M5	0.36
0820260702	G 1/8	M5	0.36
0820260703	G 1/8	M5	0.36
0820260704	G 1/8	M5	0.36

Part No.	Flow conductance		Working pressure min./max.	Control pressure min./max.
	C-value			
0820260701	3.5 l/(s*bar)		2.5 ... 10 bar	2.5 ... 10 bar
0820260702	3.5 l/(s*bar)		3 ... 10 bar	3 ... 10 bar
0820260703	3.5 l/(s*bar)		-0.9 ... 10 bar	2 ... 10 bar
0820260704	3.5 l/(s*bar)		-0.9 ... 10 bar	2.5 ... 10 bar

Nominal flow Qn at 6 bar and $\Delta p = 1$ bar

Technical information

The min. control pressure must be adhered to, since otherwise faulty switching and valve failure may result!
 The pressure dew point must be at least 15 °C under ambient and medium temperature and may not exceed 3 °C .
 The oil content of compressed air must remain constant during the life cycle.
 Use only the approved oils from AVENTICS. Further information can be found in the "Technical information" document (available in the MediaCentre).

Caution: The minimum control pressure depends on the working pressure (see "Control pressure" diagram below).

Technical information

Material	
Housing	Polyamide fiber-glass reinforced
Seals	Acrylonitrile butadiene rubber
Front plate	Polyamide fiber-glass reinforced
Threaded bushing	Brass Die cast zinc, chrome-plated nickel-plated

Diagrams

Control pressure

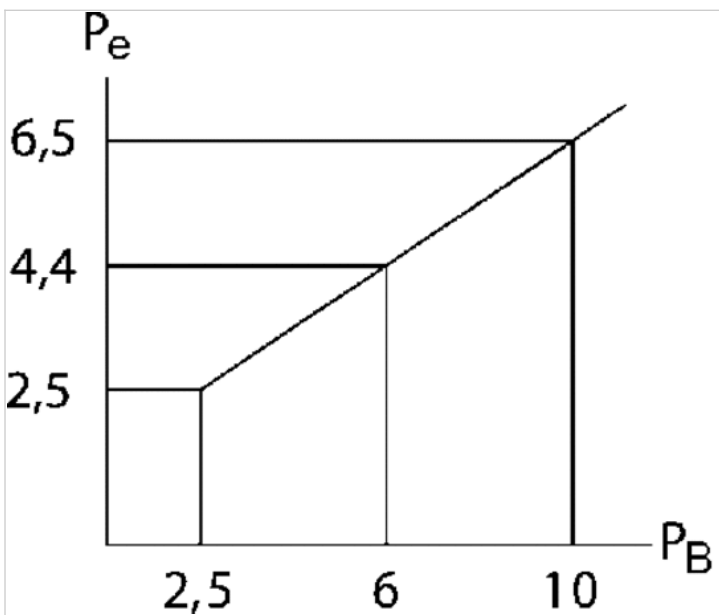

P_e = external control pressure, min.

P_B = Working pressure



5/3-directional valve, Series TC08

- Qn = 700 l/min
- Compressed air connection output G 1/8
- Plate connection Pipe connection

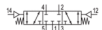

Version	Spool valve, positive overlapping
Activation	pneumatically
Pilot	External
Sealing principle	Soft sealing
Blocking principle	Plate principle
Flow rate value Qn	700 l/min
Working pressure min./max.	-0.9 ... 10 bar
Control pressure min./max.	3 ... 10 bar
Ambient temperature min./max.	-10 ... 50 °C
Medium temperature min./max.	-10 ... 50 °C
Medium	Compressed air
Max. particle size	5 µm
Oil content of compressed air	0 ... 5 mg/m ³
Weight	0.092 kg

Technical data

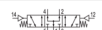
Part No.			Compressed air connection	
			Input	
0820261701		closed center	G 1/8	
0820261702		exhausted center	G 1/8	
0820261703		pressurized center	G 1/8	

Part No.	Compressed air connection	
	Output	Exhaust
0820261701	G 1/8	G 1/8
0820261702	G 1/8	G 1/8
0820261703	G 1/8	G 1/8

Part No.	Compressed air connection		Flow conductance	Flow conductance
	Pilot control exhaust		b	C-value
0820261701	M5		0.34	3 l/(s*bar)
0820261702	M5		0.34	3 l/(s*bar)
0820261703	M5		0.34	3 l/(s*bar)

Nominal flow Qn at 6 bar and $\Delta p = 1$ bar

Technical information

The min. control pressure must be adhered to, since otherwise faulty switching and valve failure may result!

The pressure dew point must be at least 15 °C under ambient and medium temperature and may not exceed 3 °C .

The oil content of compressed air must remain constant during the life cycle.

Use only the approved oils from AVENTICS. Further information can be found in the "Technical information" document (available in the MediaCentre).

Caution: The minimum control pressure depends on the working pressure (see "Control pressure" diagram below).

Technical information

Material

Housing	Polyamide fiber-glass reinforced
Seals	Acrylonitrile butadiene rubber
Front plate	Polyamide fiber-glass reinforced
Threaded bushing	Brass Die cast zinc, chrome-plated nickel-plated

Diagrams

Control pressure

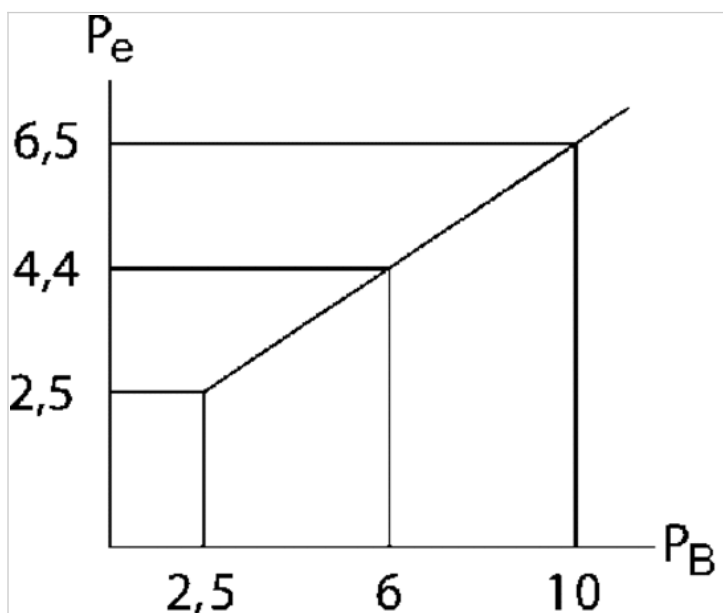

P_e = external control pressure, min.

P_B = Working pressure

Valve plug connector, series CON-VP

- Socket form C 2+E angled 90°
- open cable ends 3-pin
- with cable
- unshielded



Ambient temperature min./max.	-20 ... 80 °C
Operational voltage	See table below
Protection class	IP67
Wire cross-section	0.75 mm ²
Mounting screw tightening torque	0.4 Nm
Weight	See table below

Technical data

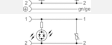
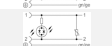
Part No.		Operational voltage	Max. current	Protective circuit	Contact assignment
1834484212		230 V AC/DC	6 A	-	2+E
1834484213		230 V AC/DC	6 A	-	2+E
1834484214		230 V AC/DC	6 A	-	2+E
1834484215		230 V AC/DC	6 A	-	2+E
1834484204		24 V AC/DC	6 A	Z-diode	2+E
1834484205		24 V AC/DC	6 A	Z-diode	2+E
1834484206		24 V AC/DC	6 A	Z-diode	2+E
1834484207		24 V AC/DC	6 A	Z-diode	2+E
1834484208		230 V AC/DC	6 A	Varistor	2+E
1834484209		230 V AC/DC	6 A	Varistor	2+E
1834484210		230 V AC/DC	6 A	Varistor	2+E
1834484211		230 V AC/DC	6 A	Varistor	2+E

Part No.	LED status display	Number of wires	Cable-Ø	Cable length	Weight	Fig.	
1834484212	-	3	5.9 mm	3 m	0.183 kg	Fig. 1	-
1834484213	-	3	5.9 mm	3 m	0.183 kg	Fig. 2	-
1834484214	-	3	5.9 mm	5 m	0.308 kg	Fig. 1	-
1834484215	-	3	5.9 mm	5 m	0.308 kg	Fig. 2	-
1834484204	Yellow	3	5.9 mm	3 m	0.185 kg	Fig. 1	1)
1834484205	Yellow	3	5.9 mm	3 m	0.185 kg	Fig. 2	1)
1834484206	Yellow	3	5.9 mm	5 m	0.292 kg	Fig. 1	1)
1834484207	Yellow	3	5.9 mm	5 m	0.298 kg	Fig. 2	1)
1834484208	Yellow	3	5.9 mm	3 m	0.171 kg	Fig. 1	1)
1834484209	Yellow	3	5.9 mm	3 m	0.194 kg	Fig. 2	1)
1834484210	Yellow	3	5.9 mm	5 m	0.297 kg	Fig. 1	1)
1834484211	Yellow	3	5.9 mm	5 m	0.285 kg	Fig. 2	1)

1) Scope of delivery incl. flat gasket

Technical information

The specified protection class is only valid in assembled and tested state.

Technical information

Material	
Seals	caoutchouc/butadiene caoutchouc
Cable sheath	Polyvinyl chloride

Dimensions

Fig. 1

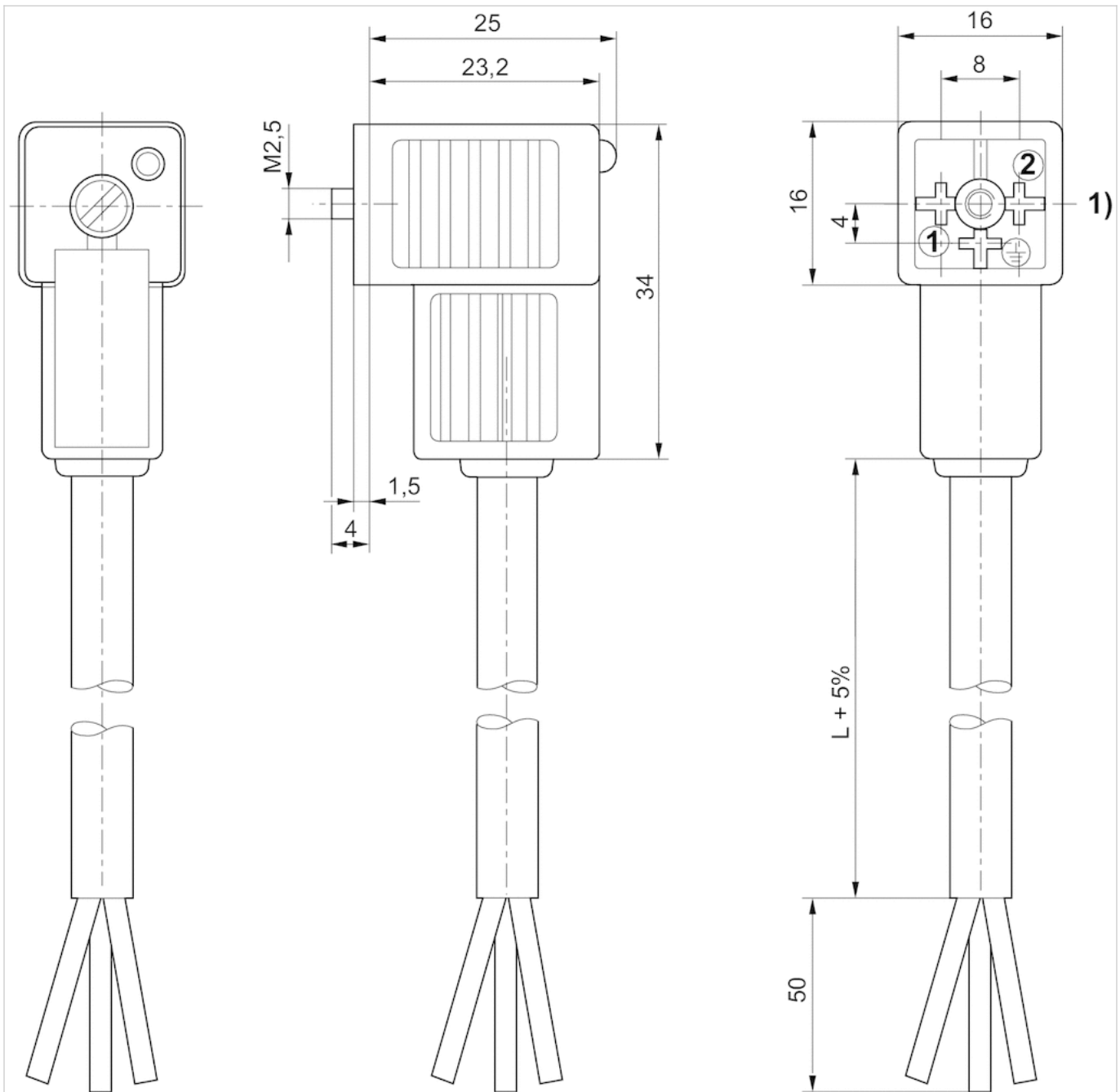

1) 0° female insert

Fig. 2

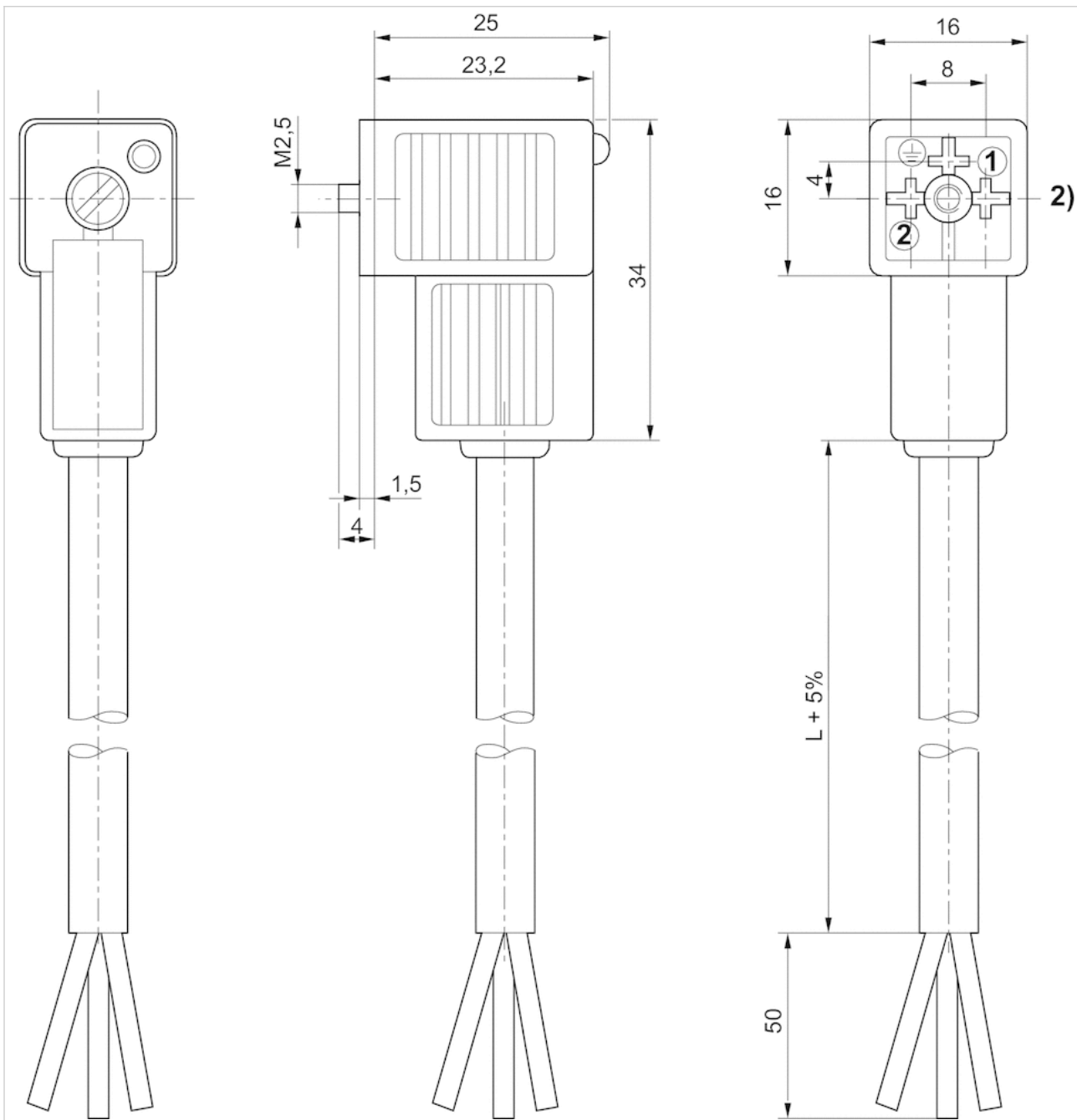

2) 180° female insert

Valve plug connector, series CON-VP

- Socket, form C, 2+E, angled, 90°
- ISO 15217
- unshielded
- with LED Green



Connection type	Screws
Ambient temperature min./max.	-40 ... 90 °C
Operational voltage	See table below
Protection class	IP65
Mounting screw tightening torque	0.4 Nm
Weight	See table below

Technical data

Part No.		Operational voltage	Max. current	Protective circuit	Contact assignment
1834484187		250 / 300 V AC/DC	6 A	-	2+E
4402050330		24 V AC/DC	-	Z-diode	2+E

Part No.	LED status display	suitable cable-Ø min./max	Seal	Weight
1834484187	-	4 / 8 mm	caoutchouc/butadiene caoutchouc	0.012 kg
4402050330	Green	-	-	0.014 kg

Part No.	Fig.	
1834484187	Fig. 1	-
4402050330	Fig. 3	1)

1)

Technical information

The specified protection class is only valid in assembled and tested state.

Technical information

Material	
Seals	caoutchouc/butadiene caoutchouc

Dimensions

Fig. 1

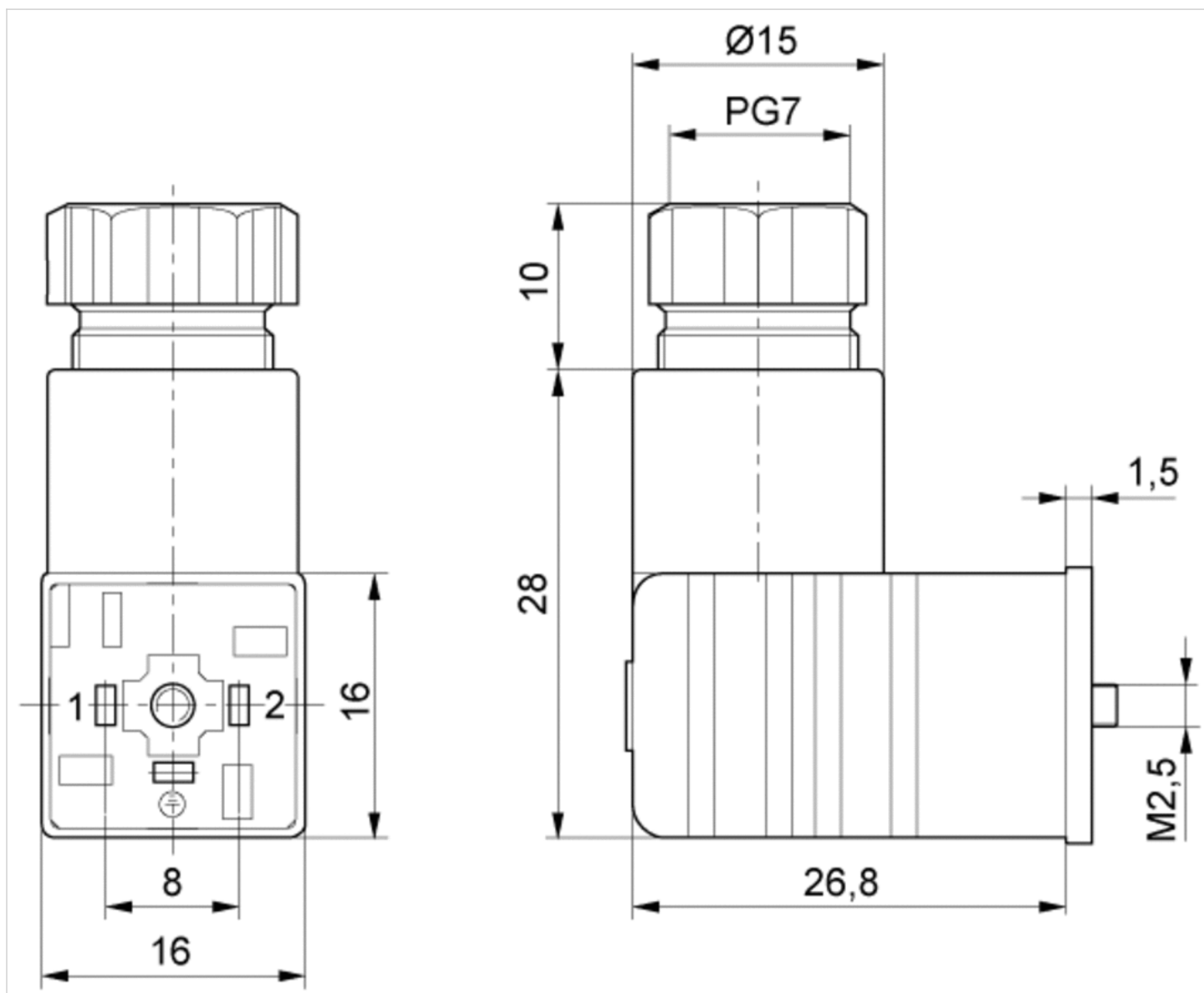

Fig. 2

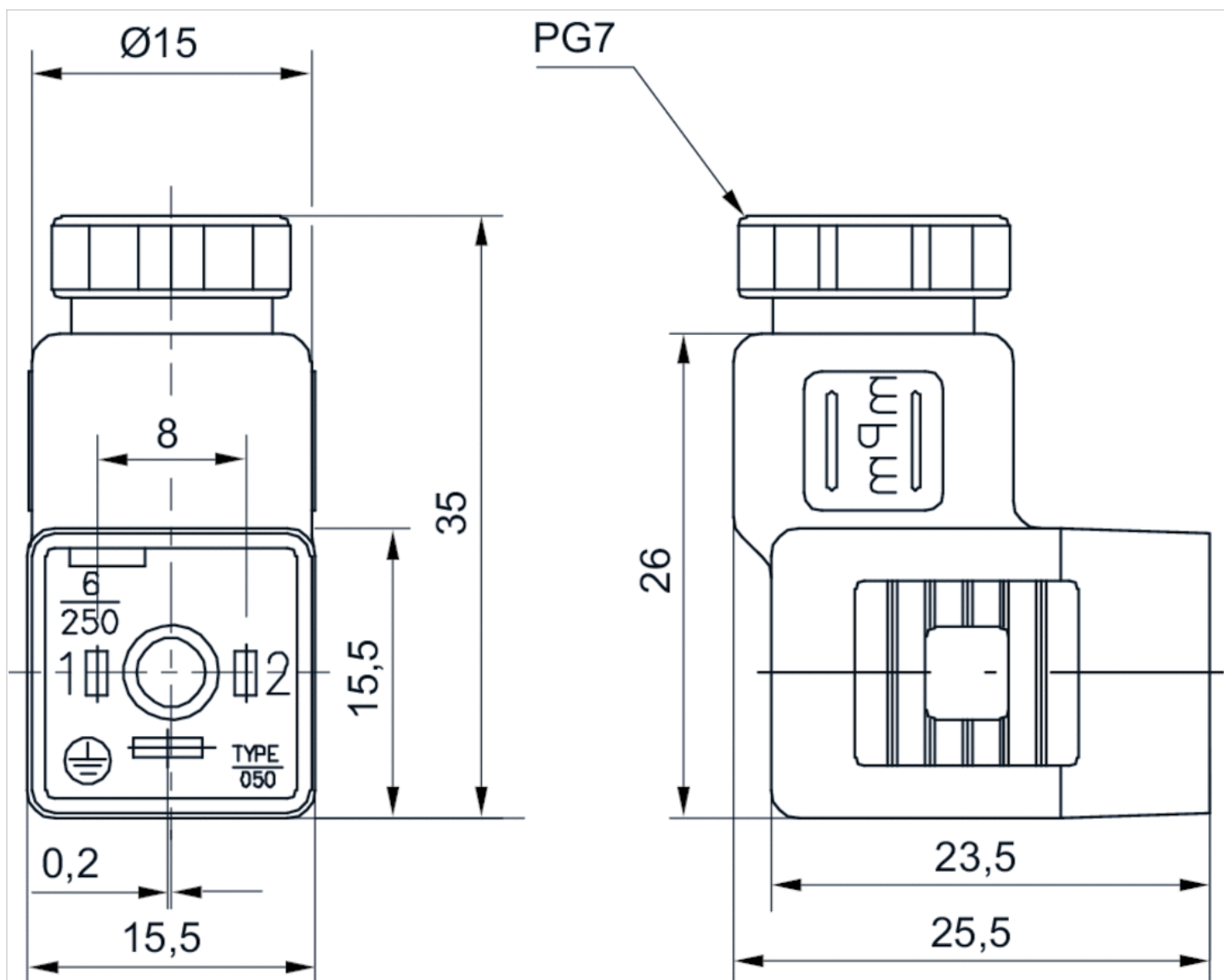
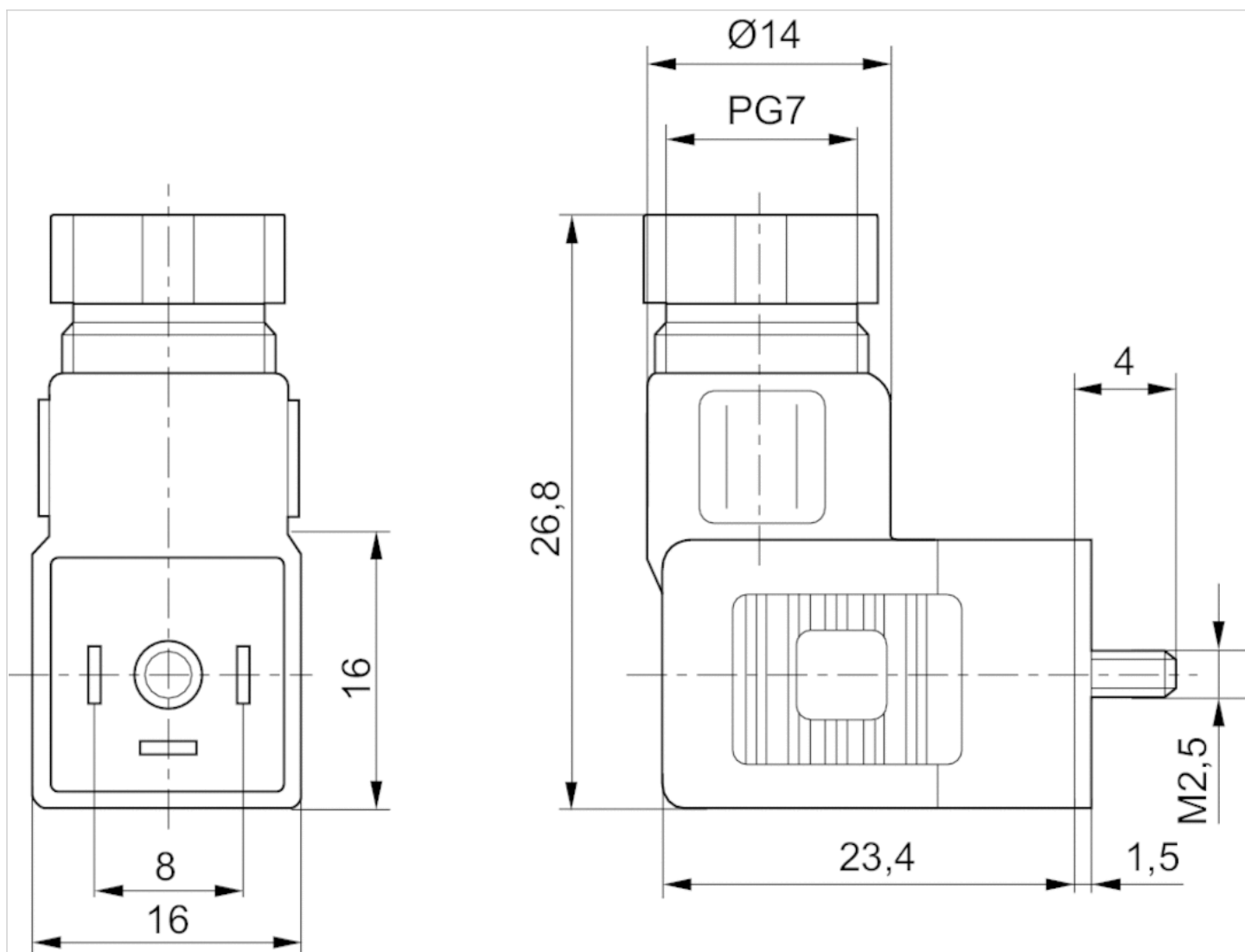

Fig. 3



Coil, Series C01

- Form C, coil kit
- Coil width 15 mm
- Power consumption DC 2 W
- Holding power AC 1.6 VA
- Switch-on power AC 2.2 VA



Connector standard	ISO 15217
electrical connections	Plug, 3-pin
Ambient temperature min./max.	-10 ... 50 °C
Protection class With valve plug connector/plug	IP65
Duty cycle ED	100 %
Weight	See table below

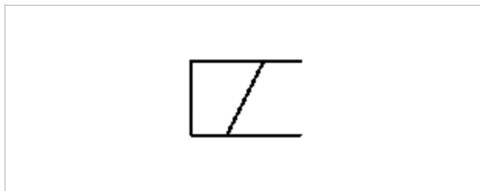

Technical data

Part No.	Operational voltage	Operational voltage	Operational voltage
	DC	AC 50 Hz	AC 60 Hz
R422101598	-	110 V	110 V
R422101599	-	230 V	230 V
R422101600	24 V	-	-
R422101601	-	24 V	24 V
R422101602	12 V	-	-

Part No.	Voltage tolerance	Voltage tolerance	Voltage tolerance	Power consumption
	DC	AC 50 Hz	AC 60 Hz	DC
R422101598	-	-10% / +10%	-10% / +10%	-
R422101599	-	-10% / +10%	-10% / +10%	-
R422101600	-10% / +10%	-	-	2 W
R422101601	-	-10% / +10%	-10% / +10%	-
R422101602	-10% / +10%	-	-	2 W

Part No.	Holding power	Holding power	Switch-on power	Switch-on power	Weight	
	AC 50 Hz	AC 60 Hz	AC 50 Hz	AC 60 Hz		
R422101598	1.6 VA	1.4 VA	2.2 VA	2 VA	0.023 kg	1)
R422101599	1.6 VA	1.4 VA	2.2 VA	2 VA	0.022 kg	1)
R422101600	-	-	-	-	0.024 kg	-
R422101601	1.6 VA	1.4 VA	2.2 VA	2 VA	0.023 kg	1)

Part No.	Holding power	Holding power	Switch-on power	Switch-on power	Weight	
	AC 50 Hz	AC 60 Hz	AC 50 Hz	AC 60 Hz		
R422101602	-	-	-	-	0.024 kg	-

1) Can only be combined with TC series base valves and TC series valves with alternating voltage (AC).

Technical information

Please note that the coils are only compatible with TC series valves that were produced starting in 2011.

Technical information

Material	
Housing	Polyamide

Dimensions

Dimensions

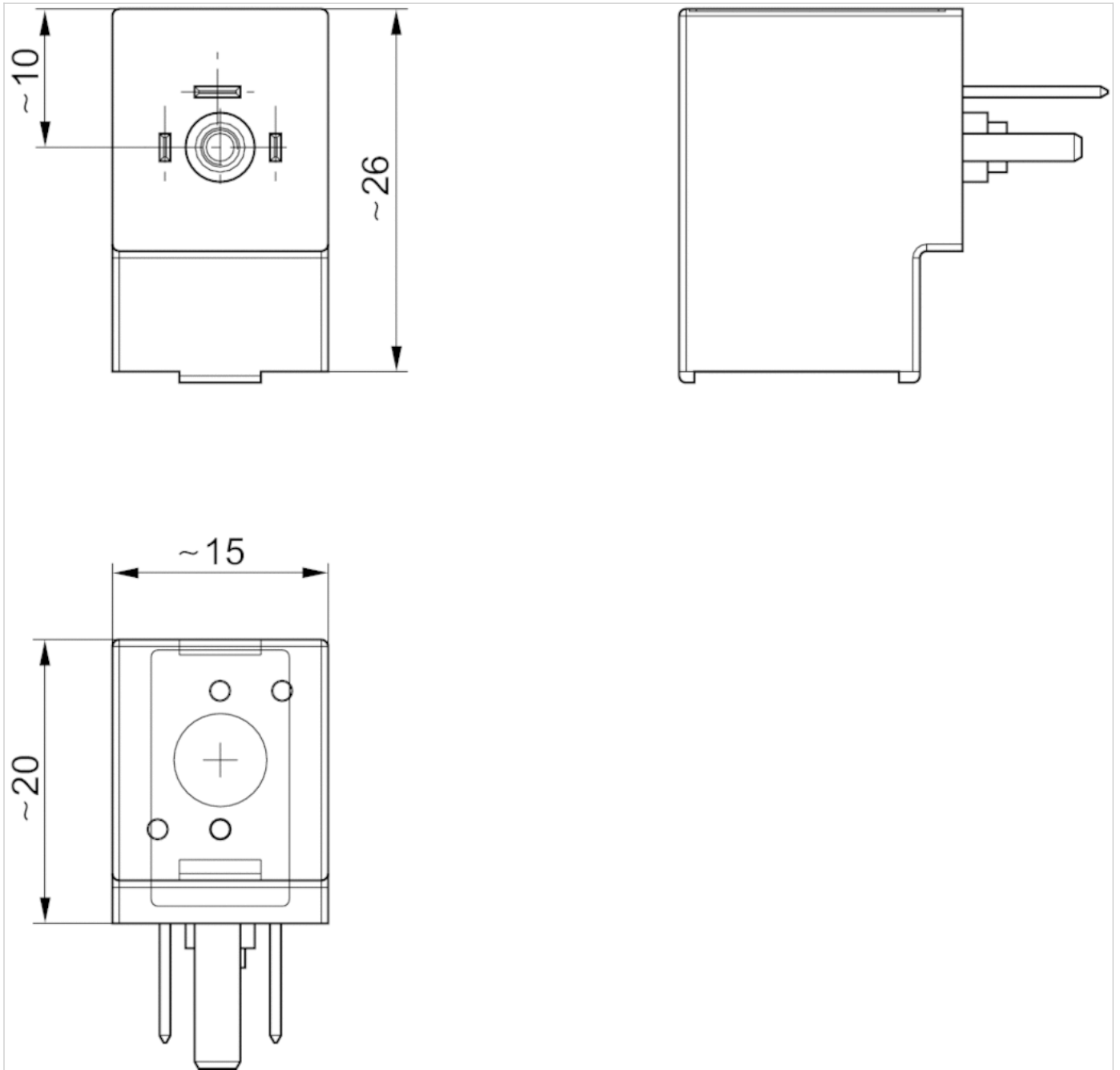

Coil, Series C01

- M8, coil kit
- Coil width 15 mm
- Power consumption DC 2.2 W



Connector standard	DIN EN 60947-5-2
electrical connections	See table below
Ambient temperature min./max.	-10 ... 50 °C
Protection class acc. to DIN EN 61140	Class III
Electrically	
Protection class With valve plug	IP65
connector/plug	
Duty cycle ED	100 %
LED status display	Yellow
Weight	0.025 kg

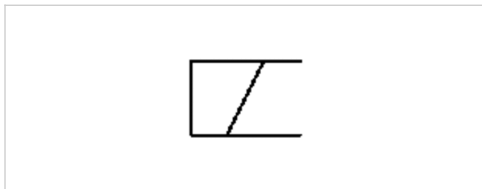

Technical data

Part No.	electrical connections	Operational voltage	Voltage tolerance
		DC	DC
R422101603	Plug, M8x1, 4-pin	24 V	-10% / +10%
R422101604	Plug, M8x1, 3-pin	24 V	-10% / +10%

Part No.	Power consumption
	DC
R422101603	2.2 W
R422101604	2.2 W

Technical information

Please note that the coils are only compatible with TC series valves that were produced starting in 2011.

Technical information

Material	
Housing	Polyamide

Dimensions

Dimensions

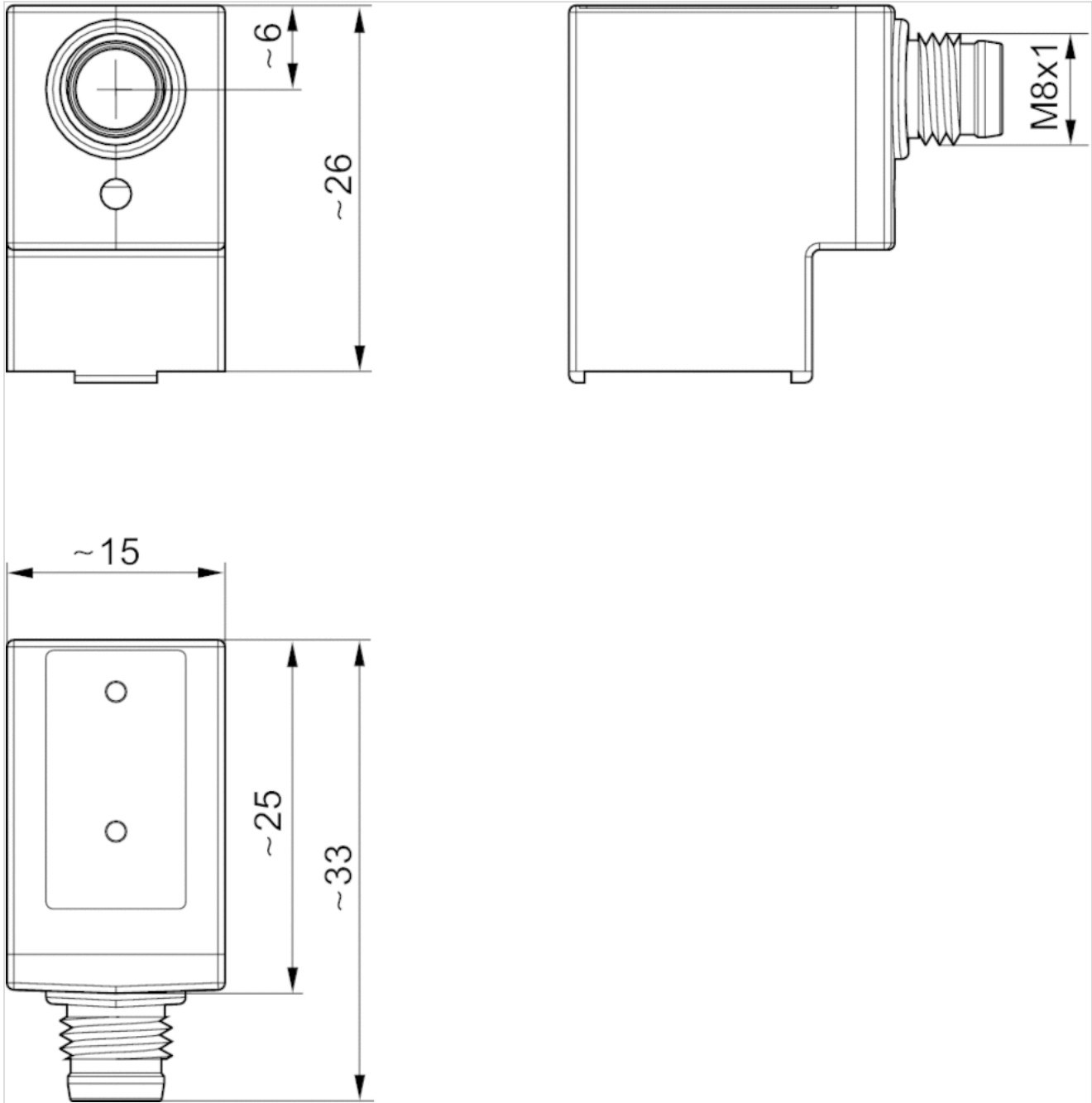

Round plug connector, Series CON-RD

- Socket M8x1 3-pin A-coded straight 180°
- open cable ends
- with cable
- UL (Underwriters Laboratories)
- unshielded



Ambient temperature min./max.	-25 ... 85 °C
Operational voltage	48 V AC/DC
Protection class	IP67
Wire cross-section	0.24 mm ²
Weight	See table below

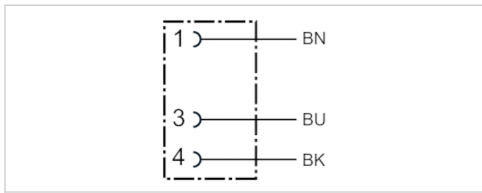

Technical data

Part No.	Max. current	Number of wires	Cable-Ø	Cable length	Certification	Weight
1834484166	4 A	3	4.5 mm	3 m	UL (Underwriters Laboratories)	0.087 kg
1834484168	4 A	3	4.5 mm	5 m	UL (Underwriters Laboratories)	0.141 kg
1834484247	4 A	3	4.5 mm	10 m	UL (Underwriters Laboratories)	0.277 kg

Technical information

The specified protection class is only valid in assembled and tested state.

Technical information

Material	
Housing	Polyurethane
Cable sheath	Polyurethane

Dimensions

Dimensions

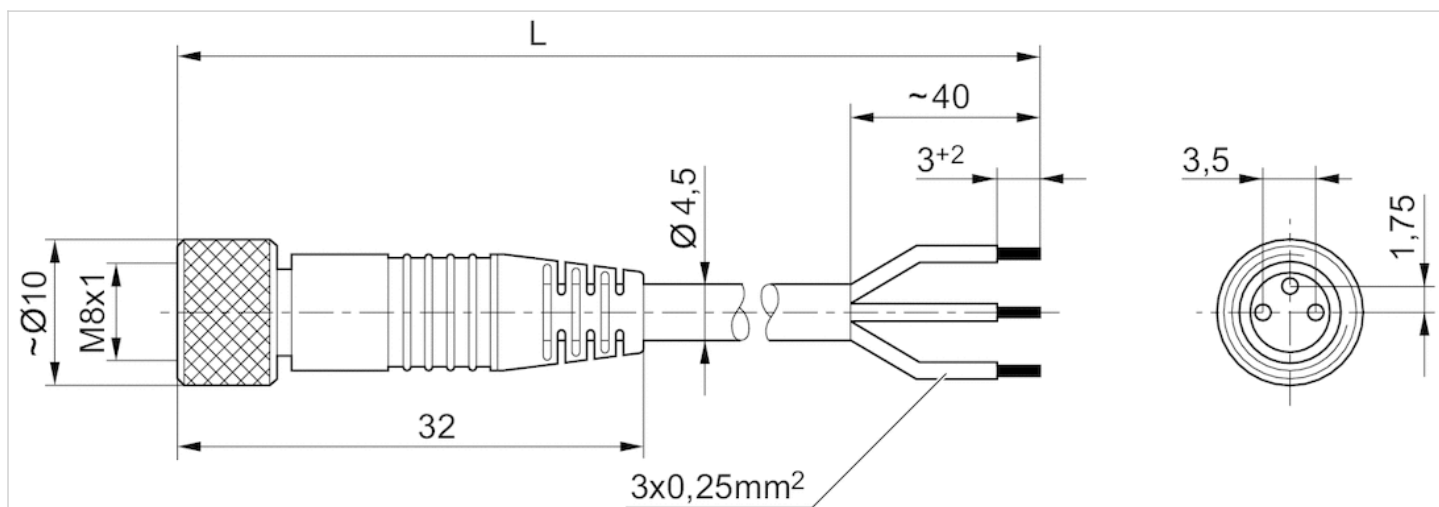

L = length

Pin assignments

Pin assignment, socket

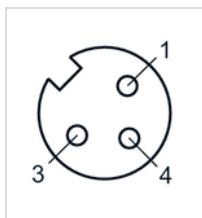

- (1) BN=brown
- (3) BU=blue
- (4) BK=black

Round plug connector, Series CON-RD

- Socket M8x1 3-pin A-coded angled 90°
- open cable ends
- with cable
- unshielded



Ambient temperature min./max.	-40 ... 85 °C
Operational voltage	48 V AC/DC
Protection class	IP67
Wire cross-section	0.24 mm ²
Weight	See table below

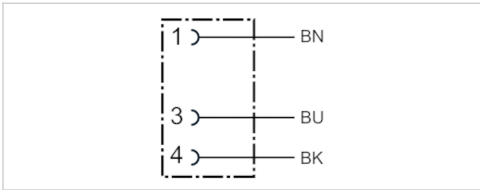

Technical data

Part No.	Max. current	Number of wires	Cable-Ø	Cable length	Weight
1834484167	4 A	3	4.5 mm	3 m	0.087 kg
1834484169	4 A	3	4.5 mm	5 m	0.139 kg
1834484248	4 A	3	4.5 mm	10 m	0.279 kg

Technical information

The specified protection class is only valid in assembled and tested state.

Technical information

Material	
Housing	Polyurethane
Cable sheath	Polyurethane

Dimensions

Dimensions

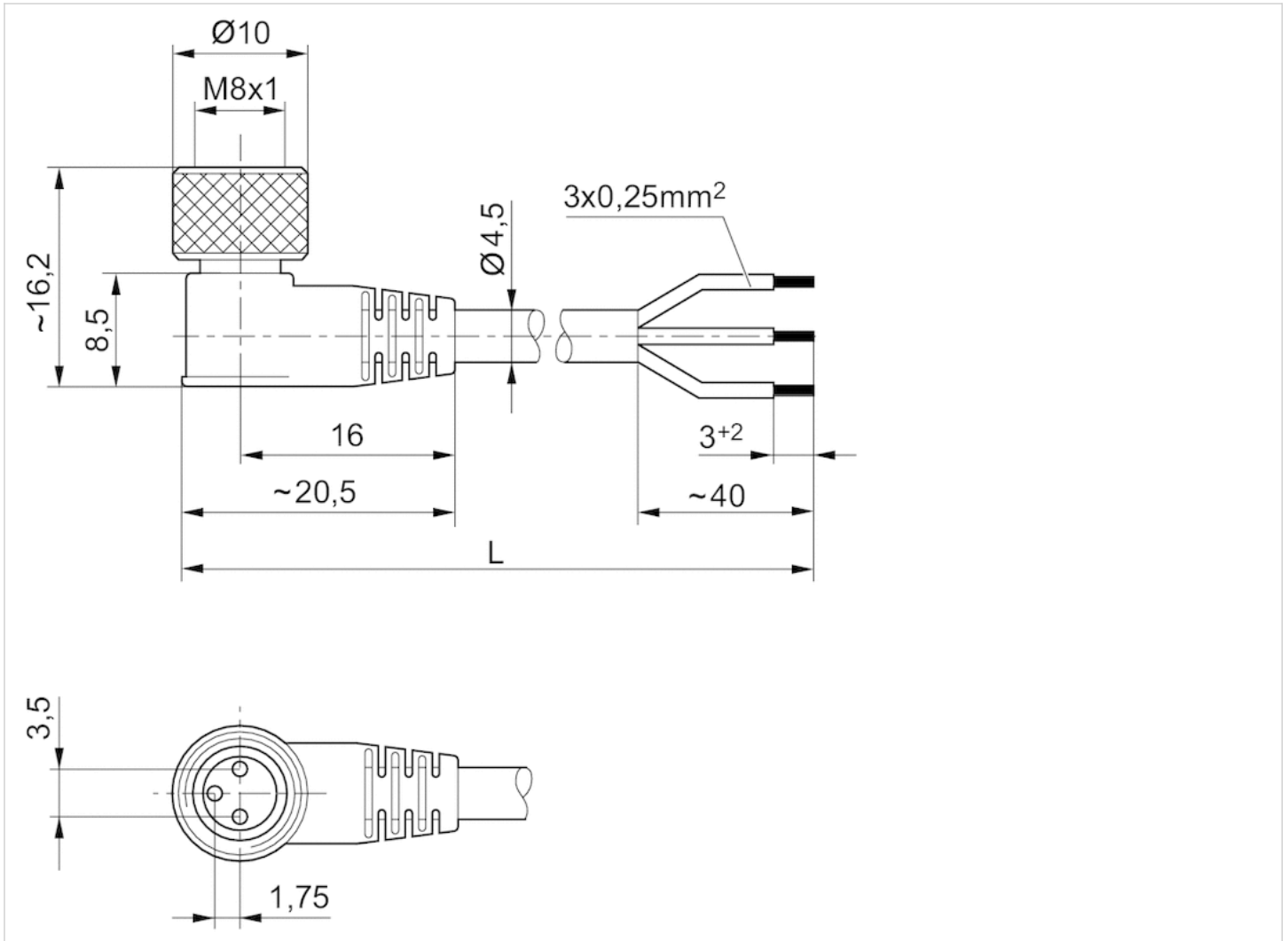

L = length

Pin assignments

Pin assignment, socket

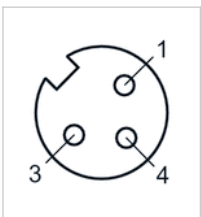

- (1) BN=brown
- (3) BU=blue
- (4) BK=black

Round plug connector, Series CON-RD

- Socket M8x1 4-pin A-coded straight 180°
- open cable ends
- with cable
- UL (Underwriters Laboratories)
- unshielded



Ambient temperature min./max.	-40 ... 85 °C
Operational voltage	48 V AC/DC
Protection class	IP67
Wire cross-section	0.25 mm ²
Weight	See table below

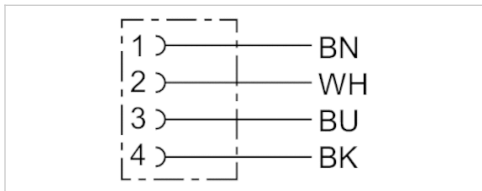

Technical data

Part No.	Max. current	Number of wires	Cable-Ø	Cable length	Certification	Weight
1834484144	4 A	4	4.5 mm	3 m	UL (Underwriters Laboratories)	0.087 kg
1834484146	4 A	4	4.5 mm	5 m	UL (Underwriters Laboratories)	0.14 kg

Technical information

The specified protection class is only valid in assembled and tested state.

Technical information

Material	
Housing	Polyurethane
Cable sheath	Polyurethane

Dimensions

Dimensions

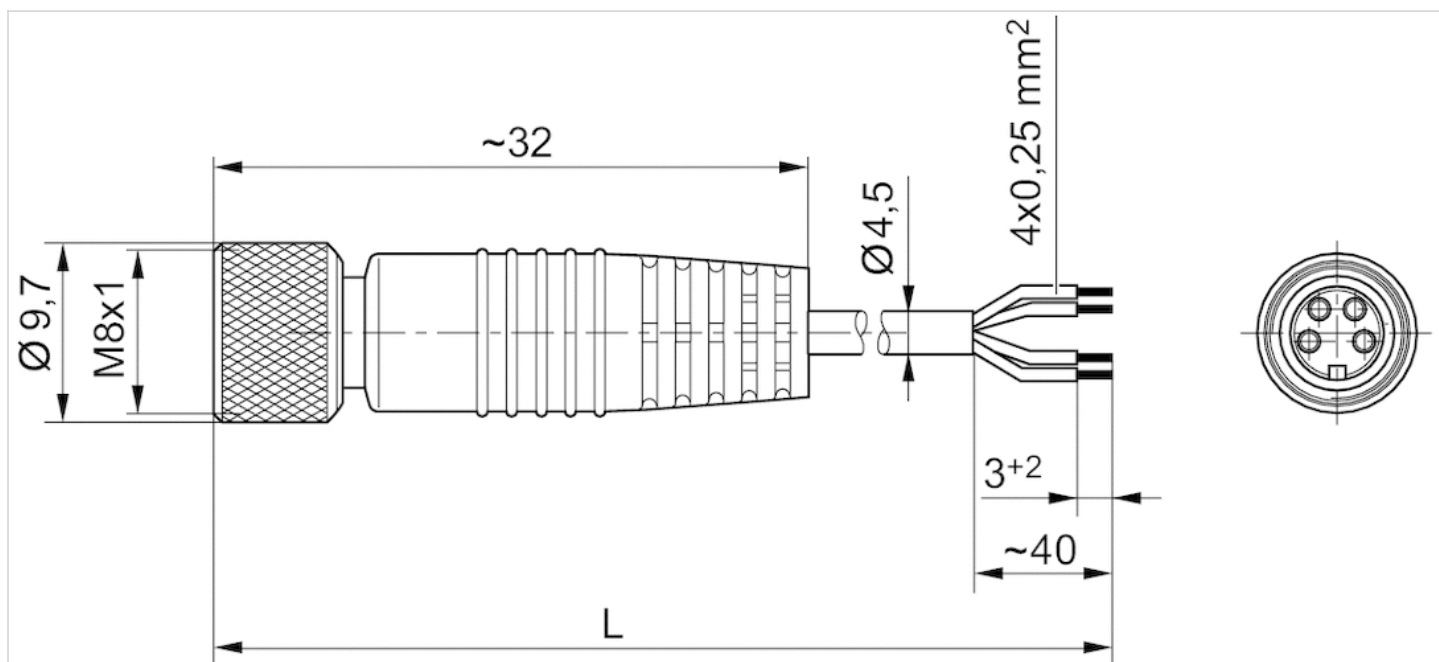

L = length

Pin assignments

Pin assignment, socket

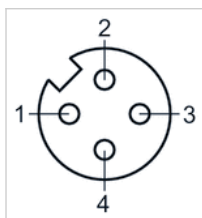

- (1) BN=brown
- (2) WH=white
- (3) BU=blue
- (4) BK=black

Round plug connector, Series CON-RD

- Socket M8x1 4-pin A-coded angled 90°
- open cable ends
- with cable
- unshielded



Ambient temperature min./max.	-25 ... 85 °C
Operational voltage	48 V AC/DC
Protection class	IP67
Wire cross-section	0.25 mm ²
Weight	See table below

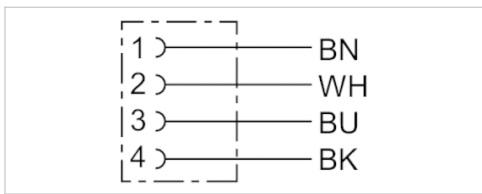

Technical data

Part No.	Max. current	Number of wires	Cable-Ø	Cable length	Weight
1834484145	4 A	4	4.5 mm	3 m	0.086 kg
1834484147	4 A	4	4.5 mm	5 m	0.141 kg

Technical information

The specified protection class is only valid in assembled and tested state.

Technical information

Material	
Housing	Polyurethane
Cable sheath	Polyurethane

Dimensions

Dimensions

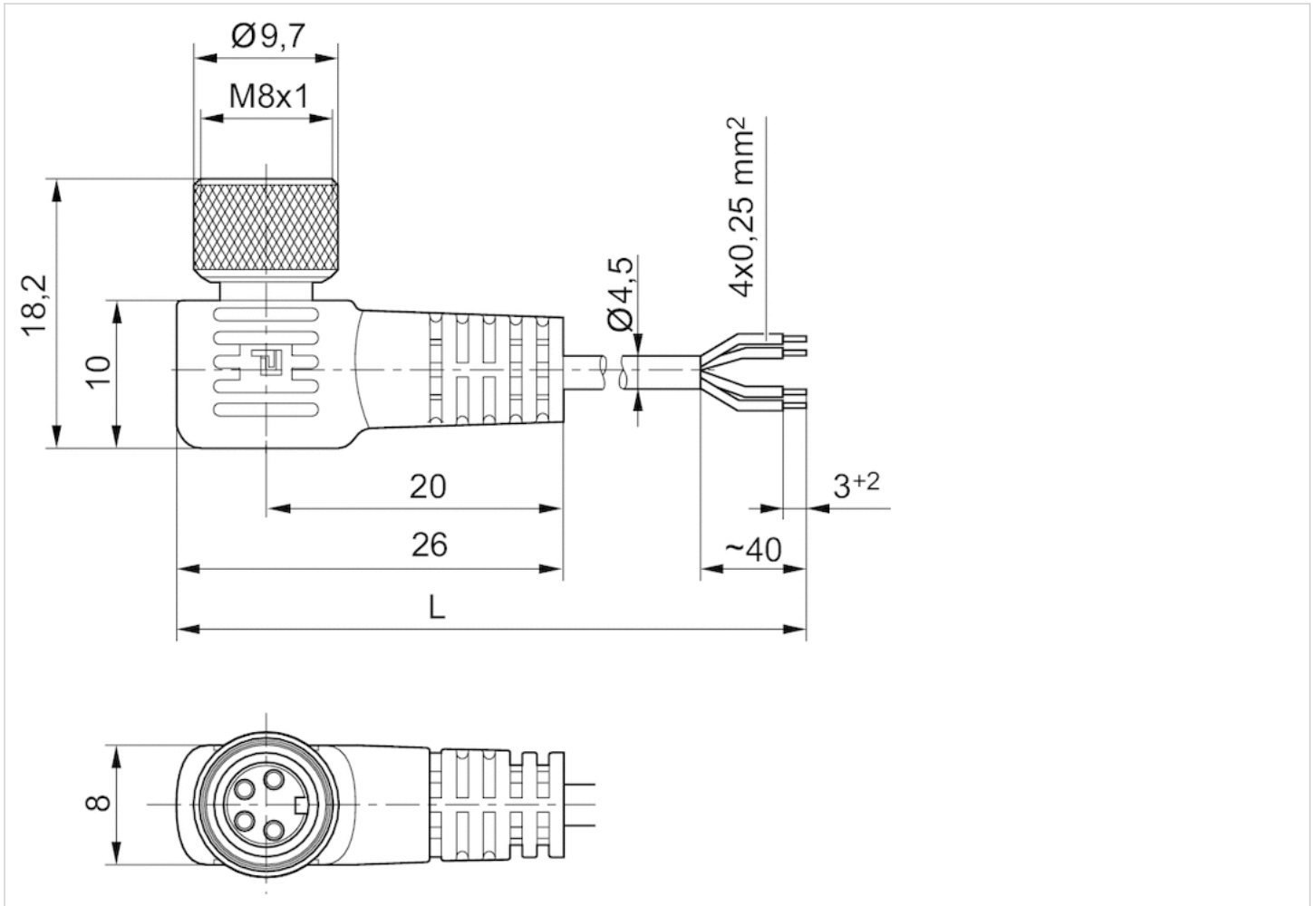

L = length

Pin assignments

Pin assignment, socket

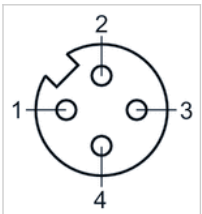

- (1) BN=brown
- (2) WH=white
- (3) BU=blue
- (4) BK=black

Round plug connector, Series CON-RD

- Socket, M8x1, 3-pin, A-coded, straight, 180°
- UL (Underwriters Laboratories)
- unshielded



Connection type	Soldering
Ambient temperature min./max.	-25 ... 80 °C
Operational voltage	48 V AC/DC
Protection class	IP67
Weight	0.009 kg

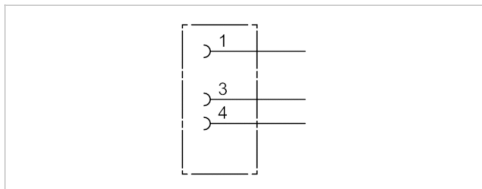

Technical data

Part No.	Max. current	suitable cable-Ø min./max
1834484173	4 A	3.5 / 5 mm

Technical information

The specified protection class is only valid in assembled and tested state.

Technical information

Material	
Housing	Polyamide

Dimensions

Dimensions

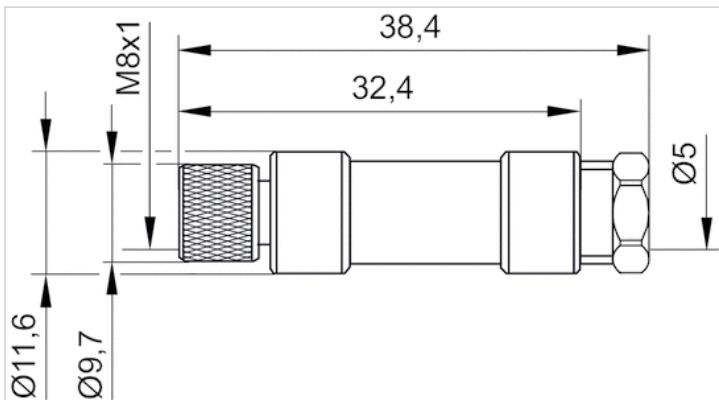

Pin assignments

Pin assignment, socket

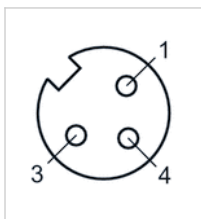

Round plug connector, Series CON-RD

- Socket, M8x1, 3-pin, A-coded, angled, 90°
- UL (Underwriters Laboratories)
- unshielded



Connection type	Soldering
Ambient temperature min./max.	-40 ... 85 °C
Operational voltage	48 V AC/DC
Protection class	IP67
Weight	0.01 kg

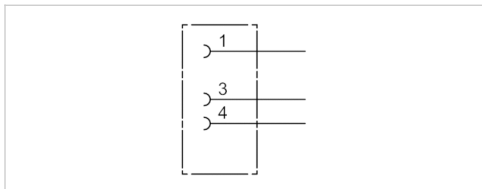

Technical data

Part No.	Max. current	Contact assignment	suitable cable-Ø min./max
1834484174	4 A	3	3.5 / 5 mm

Technical information

The specified protection class is only valid in assembled and tested state.

Technical information

Material	
Housing	Polyamide

Dimensions

Dimensions

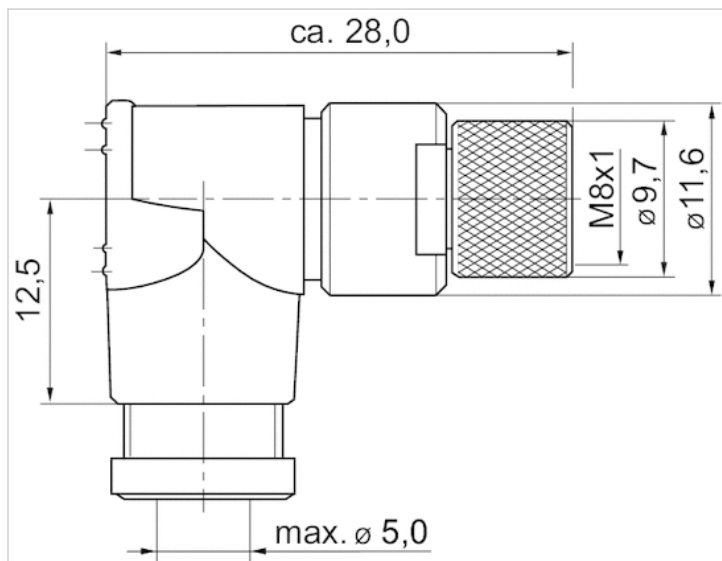

Pin assignments

Pin assignment, socket

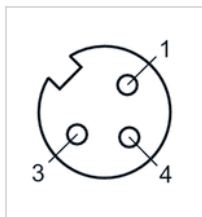

Silencers, series SI1

- G 1/8
- Sintered bronze



Working pressure min./max.	0 ... 10 bar
Ambient temperature min./max.	-25 ... 80 °C
Medium	Compressed air
Sound pressure level	75 dB
Weight	0.01 kg
Comment	Flow characteristic curves can be found under "Diagrams".

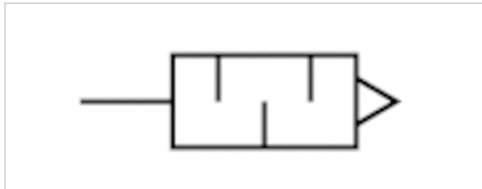

Technical data

Part No.	Compressed air connection	Flow	Delivery unit
		Qn	
1827000000	G 1/8	1623 l/min	10 piece

Weight per piece

Nominal flow Qn at p1 = 6 bar (absolute) freely discharged. Sound pressure level measured at 6 bar against atmosphere at 1 m distance.

Technical information

Material	
Silencer	Sintered bronze
Thread	Brass

Dimensions

Dimensions in mm

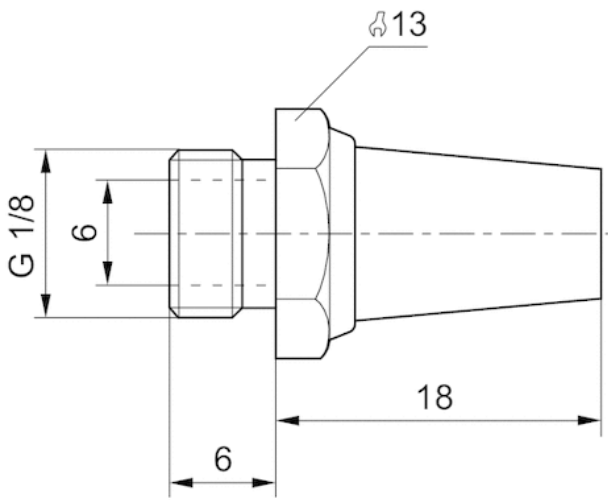

Diagrams

Flow diagram, 1827000000

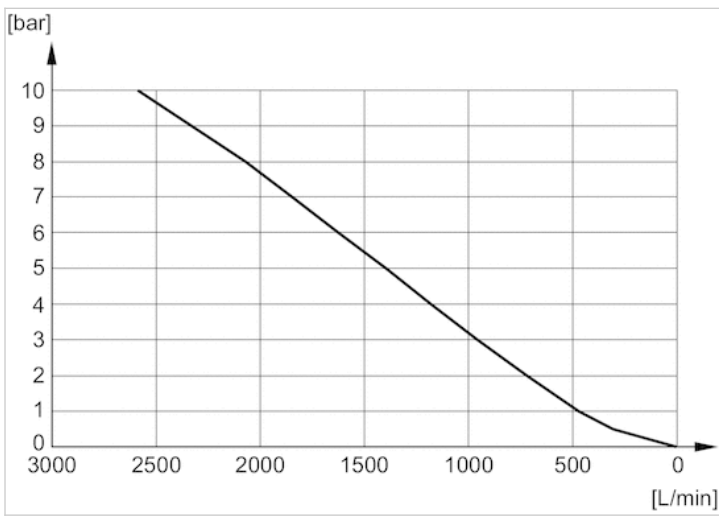

Silencers, series SI1

- G 3/8
- Sintered bronze



Working pressure min./max.	0 ... 10 bar
Ambient temperature min./max.	-25 ... 80 °C
Medium	Compressed air
Sound pressure level	84 dB
Weight	0.05 kg
Comment	Flow characteristic curves can be found under "Diagrams".

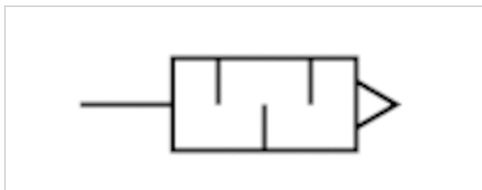

Technical data

Part No.	Compressed air connection	Flow	Delivery unit
		Qn	
1827000002	G 3/8	6554 l/min	5 piece

Weight per piece

Nominal flow Qn at p1 = 6 bar (absolute) freely discharged. Sound pressure level measured at 6 bar against atmosphere at 1 m distance.

Technical information

Material	
Silencer	Sintered bronze
Thread	Brass

Dimensions

Dimensions in mm

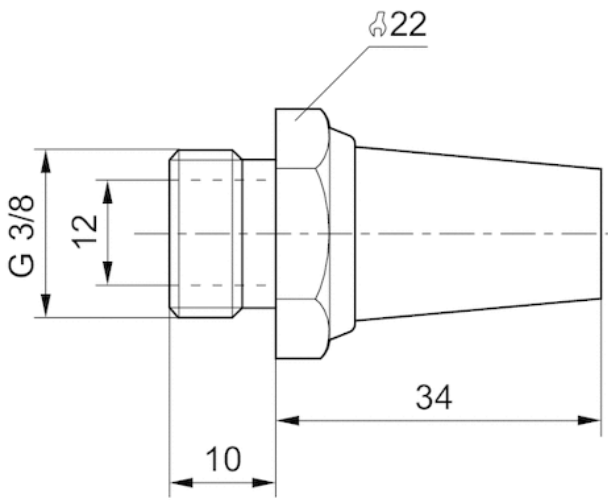

Diagrams

Flow diagram, 1827000002

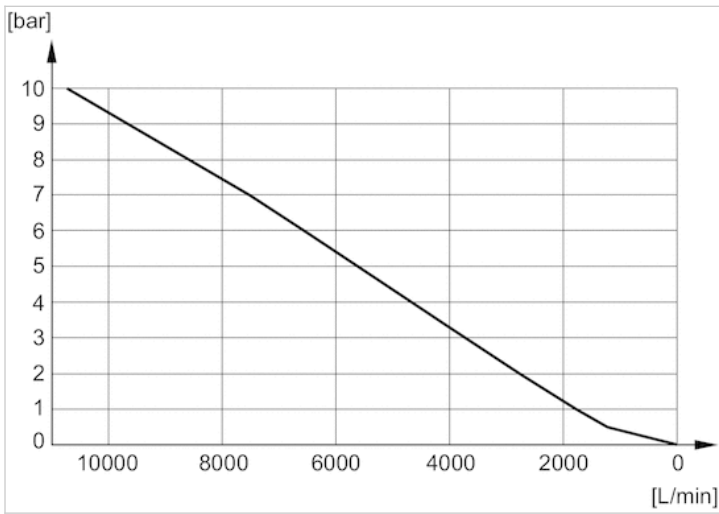

Accessories, Series TC08



Weight

See table below

Technical data

Part No.	Type	L = length
1825504355	end plate kit: internal pilot, pneumatic subbase, right	-
R422101296	End plate kit: internal pilot, right pneumatic subbase, connection thread NPTF	-
1825504356	end plate kit: external pilot, pneumatic subbase, right	-
R422101297	End plate kit: external pilot, right pneumatic subbase, connection thread NPTF	-
R422000925	end plate kit: internal pilot, pneumatic subbase, left	-
R422000926	end plate kit: external pilot, pneumatic subbase, left	-
R422000923	end plate kit: internal pilot, pneumatic subbase on both sides	-
R422000924	end plate kit: external pilot, pneumatic subbase on both sides	-
1821039041	supply/separation plate, channels 1,3,5 closed, for subbase, right	-
R422101298	Supply/separation plate, channels 1, 3, 5 closed, for right subbase, connection thread NPTF	-
R412009788	supply/separation plate, channels 1,3,5 closed, for subbase, left	-
R422000725	supply/separation plate, channel 1 closed, channels 3 and 5 open, for subbase, right	-
R422101299	Supply/separation plate, channel 1 closed, channels 3 and 5 open, for right subbase, connection thread NPTF	-
R422000501	Blanking plate	-
1821398010	Coupling kit for DIN rail mounting	-
1823053247	Tie rod, 2x, 1 piece	54.3 mm
1823053248	Tie rod, 3x, 1 piece	70.9 mm
1823053249	Tie rod, 4x, 1 piece	87.5 mm
1823053250	Tie rod, 5x, 1 piece	104.1 mm
1823053251	Tie rod, 6x, 1 piece	120.7 mm
1823053252	Tie rod, 7x, 1 piece	137.6 mm
1823053253	Tie rod, 8x, 1 piece	153.9 mm
1823053254	Tie rod, 9x, 1 piece	170.5 mm
1823053255	Tie rod, 10x, 1 piece	187.1 mm
1823053256	Tie rod, 11x, 1 piece	203.7 mm
1823053257	Tie rod, 12x, 1 piece	220.3 mm
R422000140	Sealing kit, 10 pieces	-
1820A09969	Tie rod extension, 1 piece	-

Part No.	Weight
1825504355	0.296 kg
R422101296	0.296 kg
1825504356	0.294 kg
R422101297	0.294 kg
R422000925	0.301 kg
R422000926	0.301 kg
R422000923	0.451 kg
R422000924	0.445 kg
1821039041	0.135 kg
R422101298	0.135 kg
R412009788	0.136 kg
R422000725	0.133 kg
R422101299	0.133 kg
R422000501	0.14 kg
1821398010	0.013 kg
1823053247	0.009 kg
1823053248	0.013 kg
1823053249	0.017 kg
1823053250	0.02 kg
1823053251	0.024 kg
1823053252	0.028 kg
1823053253	0.031 kg
1823053254	0.035 kg
1823053255	0.04 kg
1823053256	0.043 kg
1823053257	0.047 kg
R422000140	0.04 kg
1820A09969	0.003 kg

Dimensions

Dimensions, Tie-rods

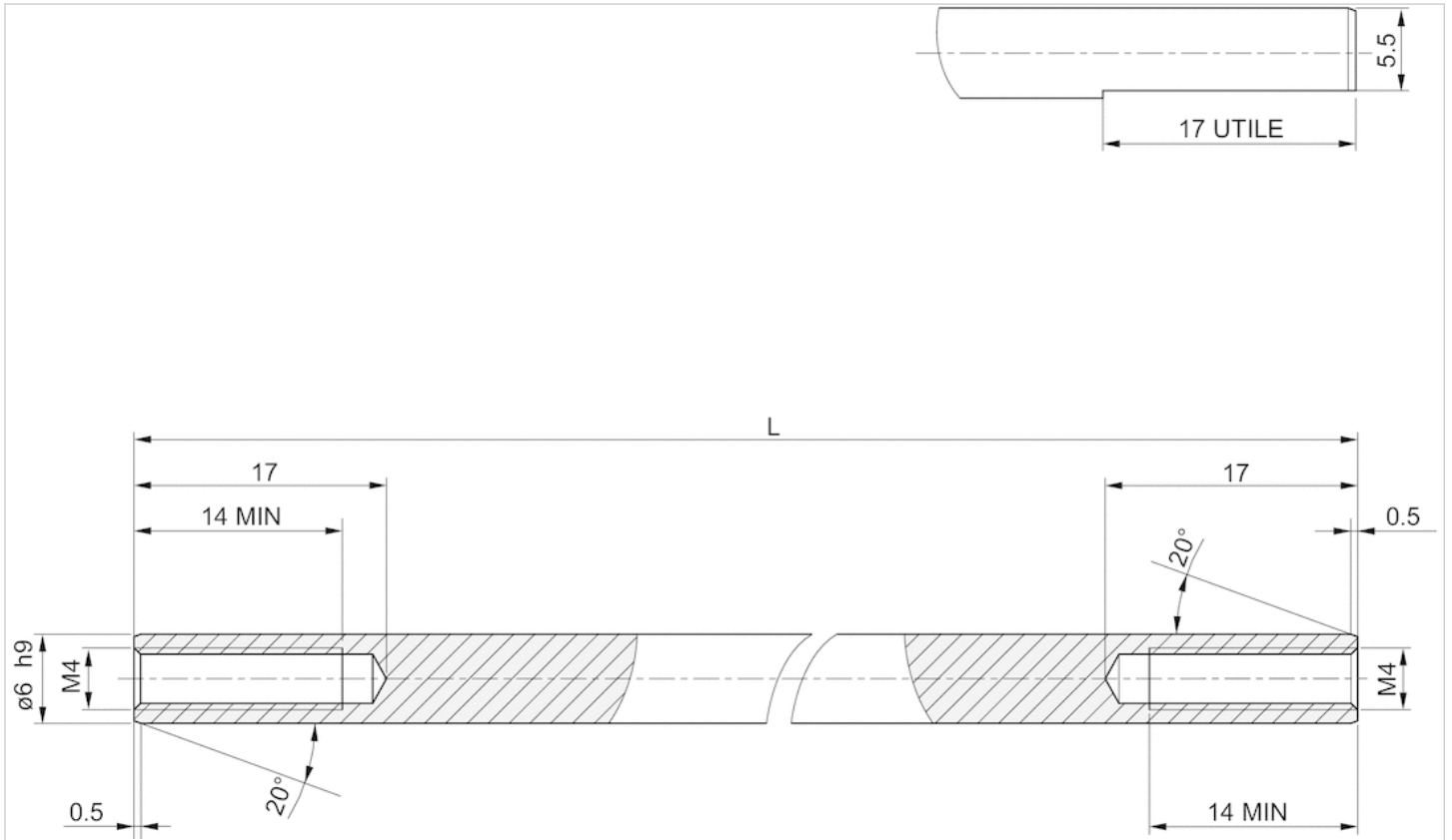

Efficient pneumatic solutions, our program: cylinders and drives, valves and valve systems, air supply management

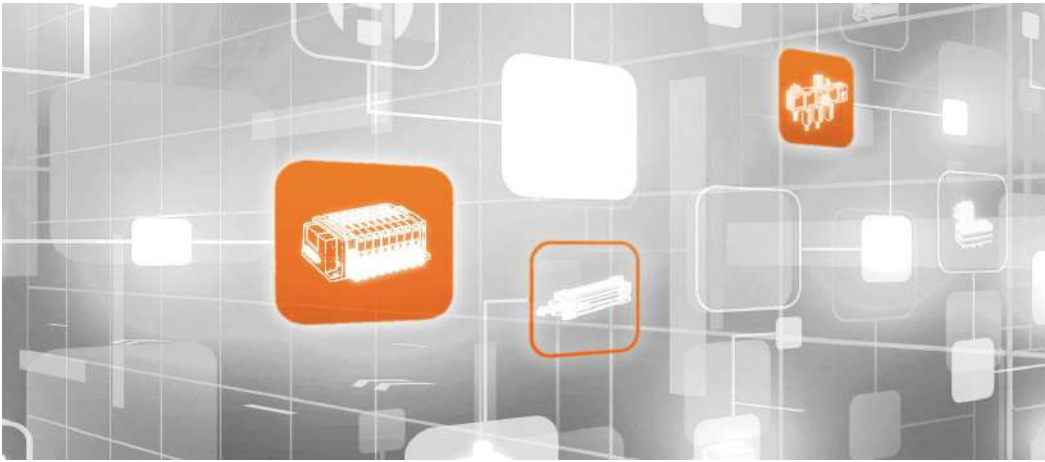

Visit us: Emerson.com/Aventics

Your local contact: Emerson.com/contactus



Emerson.com



[Facebook.com/EmersonAutomationSolutions](https://www.facebook.com/EmersonAutomationSolutions)



[LinkedIn.com/company/Emerson-Automation-Solutions](https://www.linkedin.com/company/Emerson-Automation-Solutions)



[Twitter.com/EMR_Automation](https://twitter.com/EMR_Automation)

An example configuration is depicted on the title page. The delivered product may thus vary from that in the illustration. Subject to change. This Document, as well as the data, specifications and other information set forth in it, are the exclusive property of AVENTICS GmbH. It may not be reproduced or given to third parties without its consent. Only use the AVENTICS products shown in industrial applications. Read the product documentation completely and carefully before using the product. Observe the applicable regulations and laws of the respective country. When integrating the product into applications, note the system manufacturer's specifications for safe use of the product. The data specified only serve to describe the product. No statements concerning a certain condition or suitability for a certain application can be derived from our information. The information given does not release the user from the obligation of own judgment and verification. It must be remembered that the products are subject to a natural process of wear and aging.

The Emerson logo is a trademark and service mark of Emerson Electric Co. Brand logotype are registered trademarks of one of the Emerson family of companies. All other marks are the property of their respective owners. © 2017 Emerson Electric Co. All rights reserved.
2019-03



CONSIDER IT SOLVED™