

Series WV02

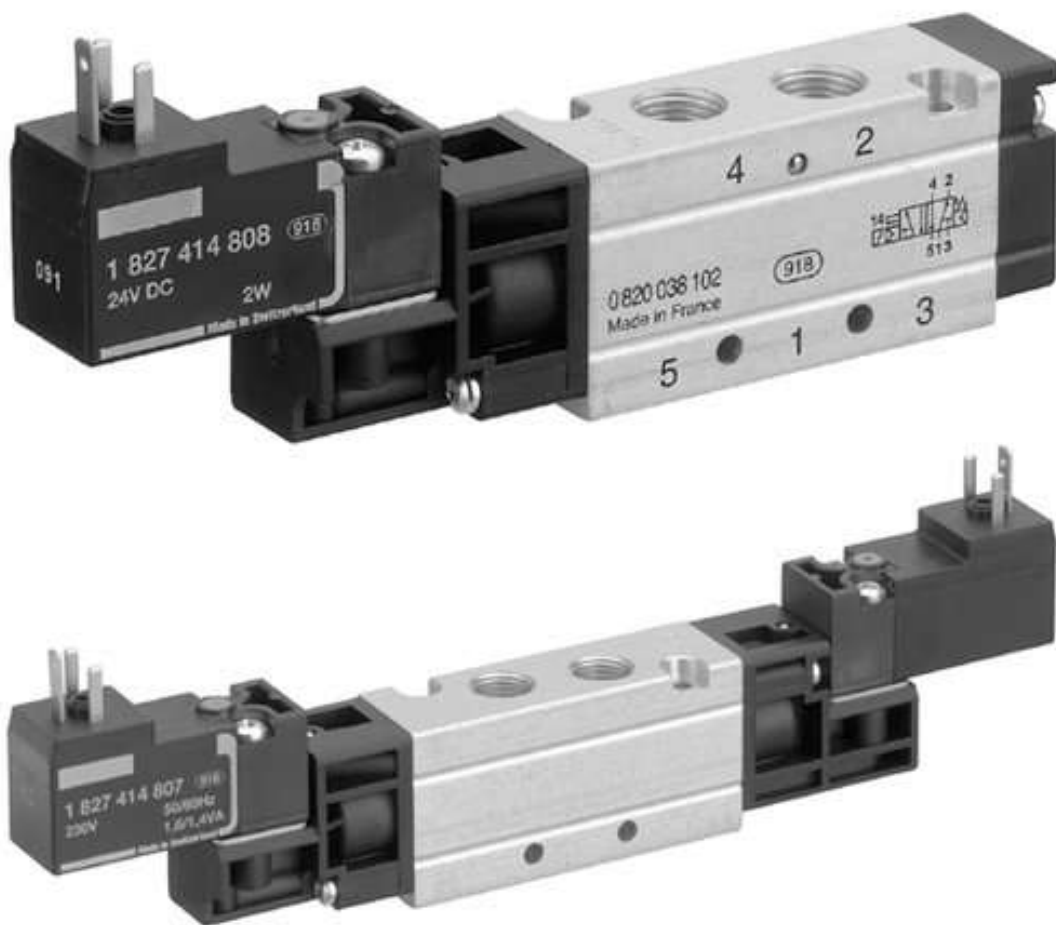

AVENTICS™ Series WV02

































2 x 3/2-directional valve, Series WV02

- 2x3/2
- Qn = 600 l/min
- Pilot valve width : 15 mm
- NC/NC NO/NO NO/NC
- Pipe connection
- Compressed air connection output : G 1/8
- Electrical connection : Plug, ISO 15217, form C
- Manual override : without detent
- Pilot : Internal



Version	Spool valve, positive overlapping
Activation	Electrically
Pilot	Internal
Sealing principle	Soft sealing
Working pressure min./max.	2.2 ... 10 bar
Control pressure min./max.	2.2 ... 10 bar
Ambient temperature min./max.	0 ... 50 °C
Medium temperature min./max.	0 ... 60 °C
Medium	Compressed air
Max. particle size	5 µm
Oil content of compressed air	0 ... 5 mg/m ³
Nominal flow Qn	600 l/min
Connector standard	ISO 15217
Protection class with connection	IP65
Duty cycle	100 %
Typ. switch-on time	12 ms
Typ. switch-off time	24 ms
Mounting on manifold strip	PRS strip
mounting screws	M3
Weight	0.16 kg

Technical data

Part No.		MO		Compressed air connection	
					Input
0820037004			NC/NC		G 1/8
0820037002			NC/NC		G 1/8
0820037003			NC/NC		G 1/8
0820037005			NC/NC		G 1/8
0820037001			NC/NC		G 1/8
0820037028			NO/NO		G 1/8
0820037026			NO/NO		G 1/8
0820037027			NO/NO		G 1/8
0820037029			NO/NO		G 1/8
0820037025			NO/NO		G 1/8
0820037053			NO/NC		G 1/8
0820037051			NO/NC		G 1/8
0820037052			NO/NC		G 1/8
0820037054			NO/NC		G 1/8
0820037050			NO/NC		G 1/8

Part No.	Compressed air connection		Operational voltage	
	Output		DC	AC 50 Hz
0820037004	G 1/8		-	24 V
0820037002	G 1/8		24 V	-
0820037003	G 1/8		24 V	-
0820037005	G 1/8		-	110 V
0820037001	G 1/8		-	230 V
0820037028	G 1/8		-	24 V
0820037026	G 1/8		24 V	-
0820037027	G 1/8		24 V	-
0820037029	G 1/8		-	110 V
0820037025	G 1/8		-	230 V
0820037053	G 1/8		-	24 V
0820037051	G 1/8		24 V	-
0820037052	G 1/8		24 V	-
0820037054	G 1/8		-	110 V
0820037050	G 1/8		-	230 V

Part No.	Operational voltage		Voltage tolerance		
	AC 60 Hz		DC	AC 50 Hz	AC 60 Hz
0820037004	24 V		-	-10% / +10%	-10% / +10%
0820037002	-		-10% / +10%	-	-
0820037003	-		-10% / +10%	-	-
0820037005	110 V		-	-10% / +10%	-10% / +10%
0820037001	230 V		-	-10% / +10%	-10% / +10%
0820037028	24 V		-	-10% / +10%	-10% / +10%
0820037026	-		-10% / +10%	-	-
0820037027	-		-10% / +10%	-	-
0820037029	110 V		-	-10% / +10%	-10% / +10%

Part No.	Operational voltage	Voltage tolerance		
		DC	AC 50 Hz	AC 60 Hz
0820037025	230 V	-	-10% / +10%	-10% / +10%
0820037053	24 V	-	-10% / +10%	-10% / +10%
0820037051	-	-10% / +10%	-	-
0820037052	-	-10% / +10%	-	-
0820037054	110 V	-	-10% / +10%	-10% / +10%
0820037050	230 V	-	-10% / +10%	-10% / +10%

Part No.	Power consumption		Holding power		Switch-on power
	DC	AC 50 Hz	AC 50 Hz	AC 60 Hz	AC 50 Hz
0820037004	-	1.6 VA	1.4 VA	1.4 VA	2.2 VA
0820037002	2 W	-	-	-	-
0820037003	1 W	-	-	-	-
0820037005	-	1.6 VA	1.4 VA	1.4 VA	2.2 VA
0820037001	-	1.6 VA	1.4 VA	1.4 VA	2.2 VA
0820037028	-	1.6 VA	1.4 VA	1.4 VA	2.2 VA
0820037026	2 W	-	-	-	-
0820037027	1 W	-	-	-	-
0820037029	-	1.6 VA	1.4 VA	1.4 VA	2.2 VA
0820037025	-	1.6 VA	1.4 VA	1.4 VA	2.2 VA
0820037053	-	1.6 VA	1.4 VA	1.4 VA	2.2 VA
0820037051	2 W	-	-	-	-
0820037052	1 W	-	-	-	-
0820037054	-	1.6 VA	1.4 VA	1.4 VA	2.2 VA
0820037050	-	1.6 VA	1.4 VA	1.4 VA	2.2 VA

Part No.	Switch-on power	
	AC 50 Hz	AC 60 Hz
0820037004	2 VA	-
0820037002	-	-
0820037003	-	1)
0820037005	2 VA	-
0820037001	2 VA	-
0820037028	2 VA	-
0820037026	-	-
0820037027	-	1)
0820037029	2 VA	-
0820037025	2 VA	-
0820037053	2 VA	-
0820037051	-	-
0820037052	-	1)
0820037054	2 VA	-
0820037050	2 VA	-

1) Low power consumption

Technical information

The min. control pressure must be adhered to, since otherwise faulty switching and valve failure may result!

The pressure dew point must be at least 15 °C under ambient and medium temperature and may not exceed 3 °C .

The oil content of compressed air must remain constant during the life cycle.

Use only the approved oils from AVENTICS. Further information can be found in the "Technical information" document (available in the MediaCentre).

Technical information

Material	
Housing	Aluminum, anodized
Seals	Hydrogenated acrylonitrile butadiene rubber
Front plate	Polyamide
Threaded bushing	Aluminum

Dimensions

Dimensions

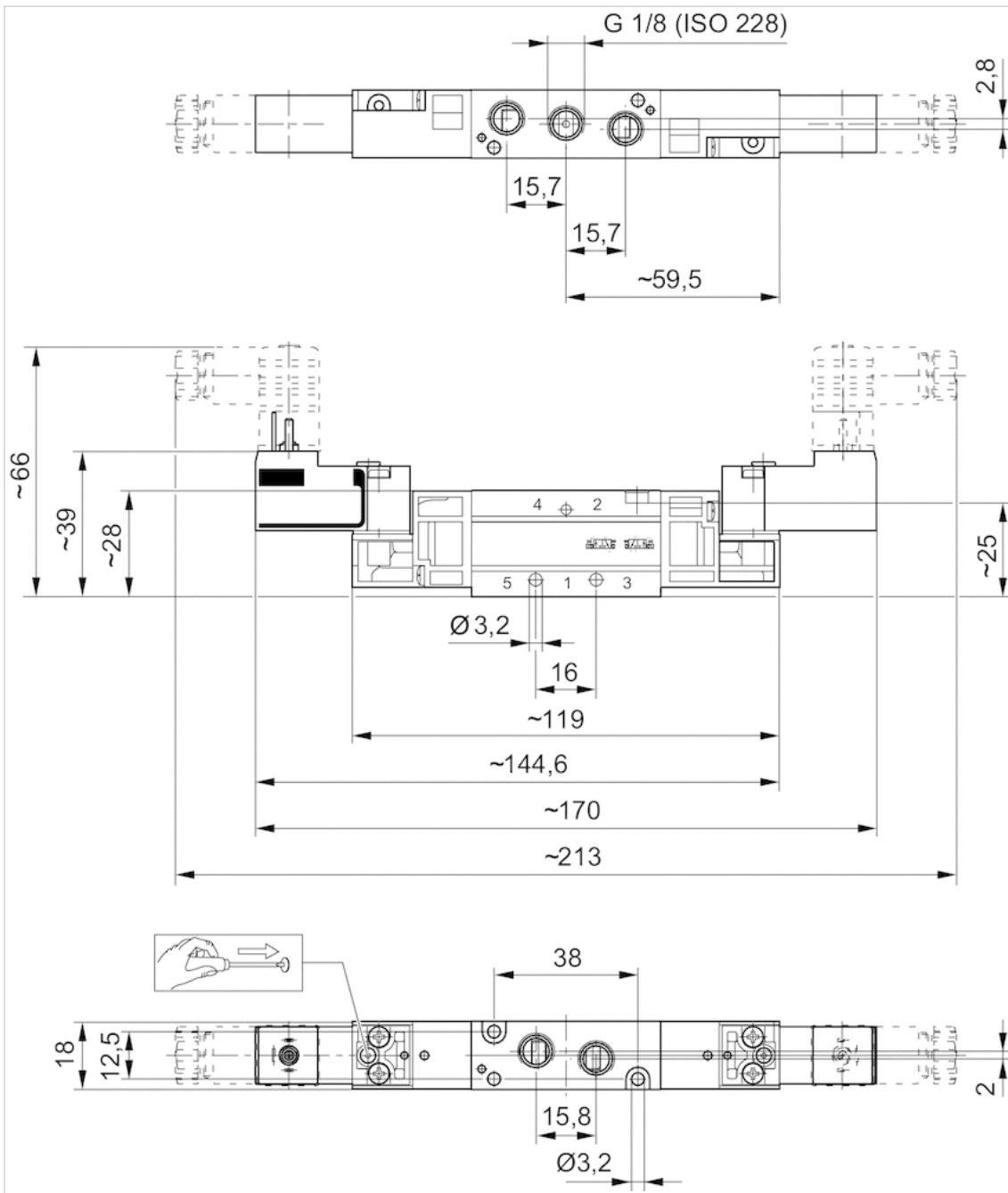































2 x 3/2-directional valve, Series WV02

- 2x3/2
- Qn = 600 l/min
- Pilot valve width : 15 mm
- NC/NC NO/NO NO/NC
- Pipe connection
- Compressed air connection output : G 1/8
- Electrical connection : Plug, ISO 15217, form C
- Manual override : with detent
- Pilot : Internal



Version	Spool valve, positive overlapping
Activation	Electrically
Pilot	Internal
Sealing principle	Soft sealing
Working pressure min./max.	2.2 ... 10 bar
Control pressure min./max.	2.2 ... 10 bar
Ambient temperature min./max.	0 ... 50 °C
Medium temperature min./max.	0 ... 60 °C
Medium	Compressed air
Max. particle size	5 µm
Oil content of compressed air	0 ... 5 mg/m ³
Nominal flow Qn	600 l/min
Connector standard	ISO 15217
Protection class with connection	IP65
Duty cycle	100 %
Typ. switch-on time	12 ms
Typ. switch-off time	24 ms
Mounting on manifold strip	PRS strip
mounting screws	M3
Weight	0.16 kg

Technical data

Part No.		MO	Compressed air connection	
				Input
0820037104			NC/NC	G 1/8
0820037102			NC/NC	G 1/8
0820037103			NC/NC	G 1/8
0820037105			NC/NC	G 1/8
0820037101			NC/NC	G 1/8
0820037128			NO/NO	G 1/8
0820037126			NO/NO	G 1/8
0820037127			NO/NO	G 1/8
0820037129			NO/NO	G 1/8
0820037125			NO/NO	G 1/8
0820037153			NO/NC	G 1/8
0820037151			NO/NC	G 1/8
0820037152			NO/NC	G 1/8
0820037154			NO/NC	G 1/8
0820037150			NO/NC	G 1/8

Part No.	Compressed air connection		Operational voltage	Operational voltage
		Output	DC	AC 50 Hz
0820037104		G 1/8	-	24 V
0820037102		G 1/8	24 V	-
0820037103		G 1/8	24 V	-
0820037105		G 1/8	-	110 V
0820037101		G 1/8	-	230 V
0820037128		G 1/8	-	24 V
0820037126		G 1/8	24 V	-
0820037127		G 1/8	24 V	-
0820037129		G 1/8	-	110 V
0820037125		G 1/8	-	230 V
0820037153		G 1/8	-	24 V
0820037151		G 1/8	24 V	-
0820037152		G 1/8	24 V	-
0820037154		G 1/8	-	110 V
0820037150		G 1/8	-	230 V

Part No.	Operational voltage	Voltage tolerance		Voltage tolerance
	AC 60 Hz	DC	AC 50 Hz	AC 60 Hz
0820037104	24 V	-	-10% / +10%	-10% / +10%
0820037102	-	-10% / +10%	-	-
0820037103	-	-10% / +10%	-	-
0820037105	110 V	-	-10% / +10%	-10% / +10%
0820037101	230 V	-	-10% / +10%	-10% / +10%
0820037128	24 V	-	-10% / +10%	-10% / +10%
0820037126	-	-10% / +10%	-	-
0820037127	-	-10% / +10%	-	-
0820037129	110 V	-	-10% / +10%	-10% / +10%

Part No.	Operational voltage	Voltage tolerance		
		DC	AC 50 Hz	AC 60 Hz
0820037125	230 V	-	-10% / +10%	-10% / +10%
0820037153	24 V	-	-10% / +10%	-10% / +10%
0820037151	-	-10% / +10%	-	-
0820037152	-	-10% / +10%	-	-
0820037154	110 V	-	-10% / +10%	-10% / +10%
0820037150	230 V	-	-10% / +10%	-10% / +10%

Part No.	Power consumption		Holding power		Switch-on power
	DC	AC 50 Hz	AC 50 Hz	AC 60 Hz	AC 50 Hz
0820037104	-	1.6 VA	1.4 VA	1.4 VA	2.2 VA
0820037102	2 W	-	-	-	-
0820037103	1 W	-	-	-	-
0820037105	-	1.6 VA	1.4 VA	1.4 VA	2.2 VA
0820037101	-	1.6 VA	1.4 VA	1.4 VA	2.2 VA
0820037128	-	1.6 VA	1.4 VA	1.4 VA	2.2 VA
0820037126	2 W	-	-	-	-
0820037127	1 W	-	-	-	-
0820037129	-	1.6 VA	1.4 VA	1.4 VA	2.2 VA
0820037125	-	1.6 VA	1.4 VA	1.4 VA	2.2 VA
0820037153	-	1.6 VA	1.4 VA	1.4 VA	2.2 VA
0820037151	2 W	-	-	-	-
0820037152	1 W	-	-	-	-
0820037154	-	1.6 VA	1.4 VA	1.4 VA	2.2 VA
0820037150	-	1.6 VA	1.4 VA	1.4 VA	2.2 VA

Part No.	Switch-on power	
	AC 60 Hz	
0820037104	2 VA	-
0820037102	-	-
0820037103	-	1)
0820037105	2 VA	-
0820037101	2 VA	-
0820037128	2 VA	-
0820037126	-	-
0820037127	-	1)
0820037129	2 VA	-
0820037125	2 VA	-
0820037153	2 VA	-
0820037151	-	-
0820037152	-	1)
0820037154	2 VA	-
0820037150	2 VA	-

1) Low power consumption

Technical information

The min. control pressure must be adhered to, since otherwise faulty switching and valve failure may result!

The pressure dew point must be at least 15 °C under ambient and medium temperature and may not exceed 3 °C .

The oil content of compressed air must remain constant during the life cycle.

Use only the approved oils from AVENTICS. Further information can be found in the "Technical information" document (available in the MediaCentre).

Technical information

Material	
Housing	Aluminum, anodized
Seals	Hydrogenated acrylonitrile butadiene rubber
Front plate	Polyamide
Threaded bushing	Aluminum

Dimensions

Dimensions

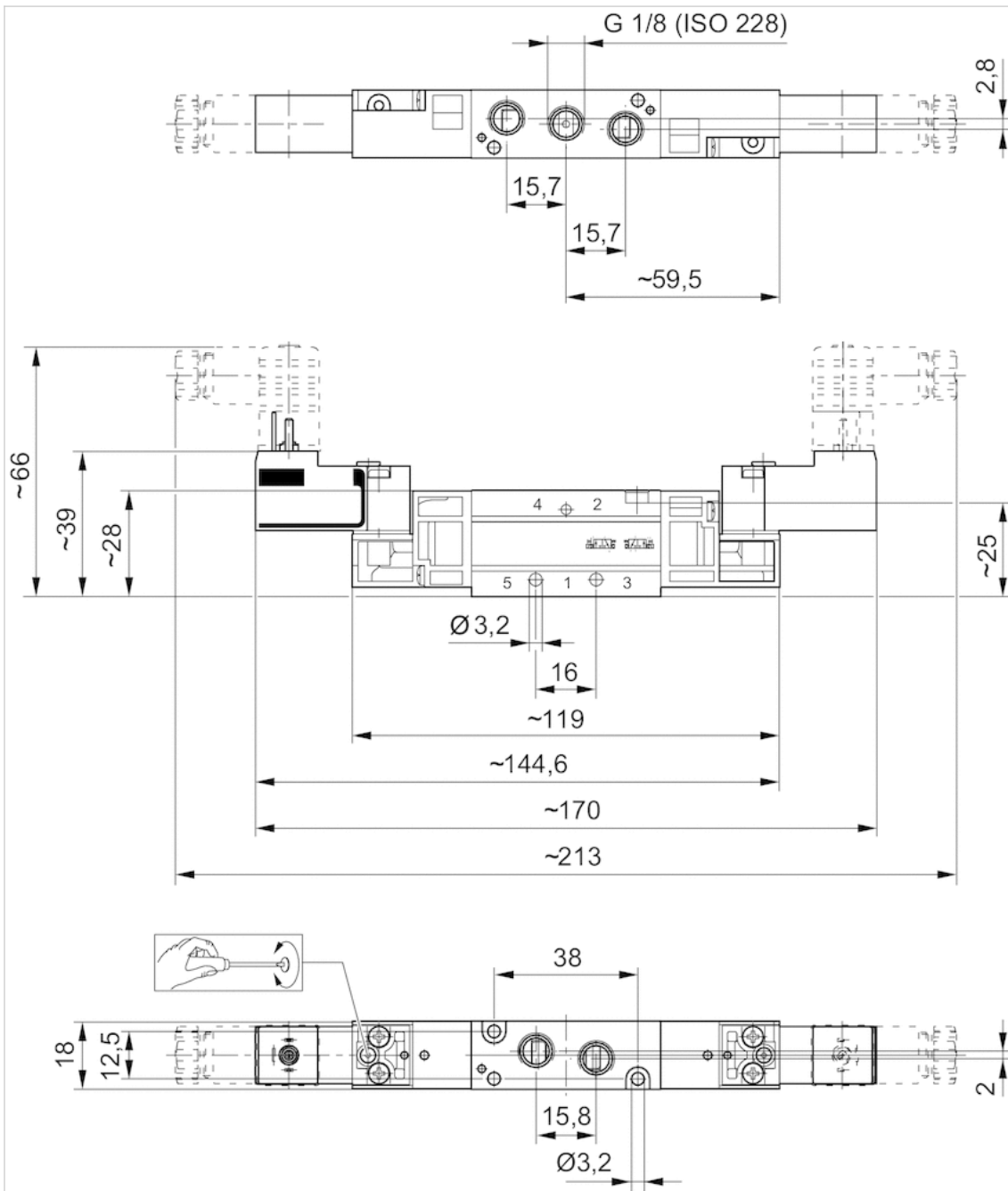





















5/2-directional valve, Series WV02

- 5/2
- Qn = 500 l/min
- Pilot valve width : 15 mm
- Pipe connection
- Compressed air connection output : G 1/8
- Electrical connection : Plug, ISO 15217, form C
- Manual override : without detent
- single solenoid double solenoid
- With spring/air spring return
- Pilot : Internal



Version	Spool valve, positive overlapping
Activation	Electrically
Pilot	Internal
Sealing principle	Soft sealing
Working pressure min./max.	See table below
Control pressure min./max.	See table below
Ambient temperature min./max.	0 ... 50 °C
Medium temperature min./max.	0 ... 60 °C
Medium	Compressed air
Max. particle size	5 µm
Oil content of compressed air	0 ... 5 mg/m ³
Nominal flow Qn	500 l/min
Connector standard	ISO 15217
Protection class with connection	IP65
Duty cycle	100 %
Mounting on manifold strip	PRS strip
mounting screws	M3
Weight	See table below

Technical data

Part No.		MO	Compressed air connection	
			Input	Output
0820038104			G 1/8	G 1/8
0820038102			G 1/8	G 1/8
0820038103			G 1/8	G 1/8
0820038105			G 1/8	G 1/8
0820038101			G 1/8	G 1/8
0820038604			G 1/8	G 1/8
0820038602			G 1/8	G 1/8
0820038603			G 1/8	G 1/8
0820038605			G 1/8	G 1/8
0820038601			G 1/8	G 1/8

Part No.	Operational voltage		Operational voltage
	DC	AC 50 Hz	AC 60 Hz
0820038104	-	24 V	24 V
0820038102	24 V	-	-
0820038103	24 V	-	-
0820038105	-	110 V	110 V
0820038101	-	230 V	230 V
0820038604	-	24 V	24 V
0820038602	24 V	-	-
0820038603	24 V	-	-
0820038605	-	110 V	110 V
0820038601	-	230 V	230 V

Part No.	Voltage tolerance	Voltage tolerance	Voltage tolerance	Power consumption
	DC	AC 50 Hz	AC 60 Hz	DC
0820038104	-	-10% / +10%	-10% / +10%	-
0820038102	-10% / +10%	-	-	2 W
0820038103	-10% / +10%	-	-	1 W
0820038105	-	-10% / +10%	-10% / +10%	-
0820038101	-	-10% / +10%	-10% / +10%	-
0820038604	-	-10% / +10%	-10% / +10%	-
0820038602	-10% / +10%	-	-	2 W
0820038603	-10% / +10%	-	-	1 W
0820038605	-	-10% / +10%	-10% / +10%	-
0820038601	-	-10% / +10%	-10% / +10%	-

Part No.	Holding power		Switch-on power	
	AC 50 Hz	AC 60 Hz	AC 50 Hz	AC 60 Hz
0820038104	1.6 VA	1.4 VA	2.2 VA	2 VA
0820038102	-	-	-	-
0820038103	-	-	-	-
0820038105	1.6 VA	1.4 VA	2.2 VA	2 VA
0820038101	1.6 VA	1.4 VA	2.2 VA	2 VA
0820038604	1.6 VA	1.4 VA	2.2 VA	2 VA
0820038602	-	-	-	-

Part No.	Holding power	Holding power	Switch-on power	Switch-on power
	AC 50 Hz	AC 60 Hz	AC 50 Hz	AC 60 Hz
0820038603	-	-	-	-
0820038605	1.6 VA	1.4 VA	2.2 VA	2 VA
0820038601	1.6 VA	1.4 VA	2.2 VA	2 VA

Part No.	Working pressure min./max.	Control pressure min./max.	Typ. switch-on time	Typ. switch-off time
0820038104	2 ... 10 bar	2 ... 10 bar	11 ms	14 ms
0820038102	2 ... 10 bar	2 ... 10 bar	11 ms	14 ms
0820038103	2 ... 10 bar	2 ... 10 bar	12 ms	16 ms
0820038105	2 ... 10 bar	2 ... 10 bar	11 ms	14 ms
0820038101	2 ... 10 bar	2 ... 10 bar	11 ms	14 ms
0820038604	1.5 ... 10 bar	1.5 ... 10 bar	8 ms	-
0820038602	1.5 ... 10 bar	1.5 ... 10 bar	8 ms	-
0820038603	1.5 ... 10 bar	1.5 ... 10 bar	10 ms	-
0820038605	1.5 ... 10 bar	1.5 ... 10 bar	8 ms	-
0820038601	1.5 ... 10 bar	1.5 ... 10 bar	8 ms	-

Part No.	Weight	
0820038104	0.11 kg	-
0820038102	0.11 kg	-
0820038103	0.11 kg	1)
0820038105	0.11 kg	-
0820038101	0.11 kg	-
0820038604	0.16 kg	-
0820038602	0.16 kg	-
0820038603	0.16 kg	1)
0820038605	0.16 kg	-
0820038601	0.16 kg	-

1) Low power consumption

Technical information

The min. control pressure must be adhered to, since otherwise faulty switching and valve failure may result!

The pressure dew point must be at least 15 °C under ambient and medium temperature and may not exceed 3 °C .

The oil content of compressed air must remain constant during the life cycle.

Use only the approved oils from AVENTICS. Further information can be found in the "Technical information" document (available in the MediaCentre).

Technical information

Material	
Housing	Aluminum, anodized
Seals	Hydrogenated acrylonitrile butadiene rubber
Front plate	Polyamide
Threaded bushing	Aluminum

Dimensions

Dimensions

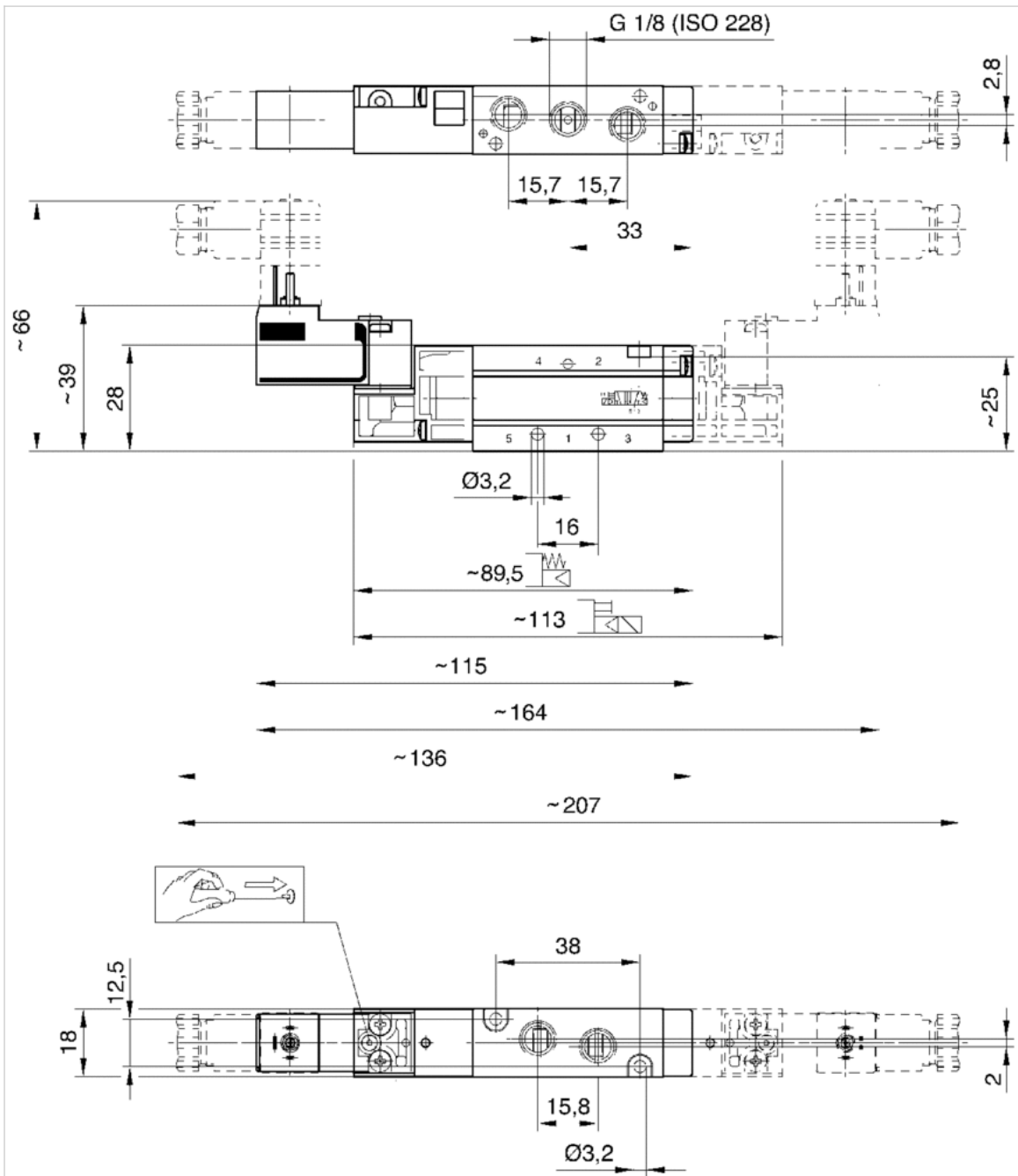

5/2-directional valve, Series WV02

- 5/2
- Qn = 500 l/min
- Pilot valve width : 15 mm
- Pipe connection
- Compressed air connection output : G 1/8
- Electrical connection : Plug, ISO 15217, form C
- Single or double solenoid
- With spring/air spring return
- Pilot : Internal



Version	Spool valve, positive overlapping
Activation	Electrically
Pilot	Internal
Sealing principle	Soft sealing
Working pressure min./max.	See table below
Control pressure min./max.	See table below
Ambient temperature min./max.	0 ... 50 °C
Medium temperature min./max.	0 ... 60 °C
Medium	Compressed air
Max. particle size	5 µm
Oil content of compressed air	0 ... 5 mg/m ³
Nominal flow Qn	500 l/min
Connector standard	ISO 15217
Protection class with connection	IP65
Duty cycle	100 %
Mounting on manifold strip	PRS strip
mounting screws	M3
Weight	See table below

Technical data

Part No.		Compressed air connection	
		Input	Output
0820038951		G 1/8	G 1/8
0820038953		G 1/8	G 1/8

Part No.	Working pressure min./max.	Control pressure min./max.	basic valve with electrical connector
0820038951	2 ... 10 bar	2 ... 10 bar	Basic valve without coil
0820038953	1.5 ... 10 bar	1.5 ... 10 bar	Basic valve without coil

Part No.	Weight
0820038951	0.08 kg
0820038953	0.1 kg

Low power consumption

Technical information

The min. control pressure must be adhered to, since otherwise faulty switching and valve failure may result!

The pressure dew point must be at least 15 °C under ambient and medium temperature and may not exceed 3 °C .

The oil content of compressed air must remain constant during the life cycle.

Use only the approved oils from AVENTICS. Further information can be found in the "Technical information" document (available in the MediaCentre).

Technical information

Material	
Housing	Aluminum, anodized
Seals	Hydrogenated acrylonitrile butadiene rubber
Front plate	Polyamide
Threaded bushing	Aluminum

Dimensions

Dimensions

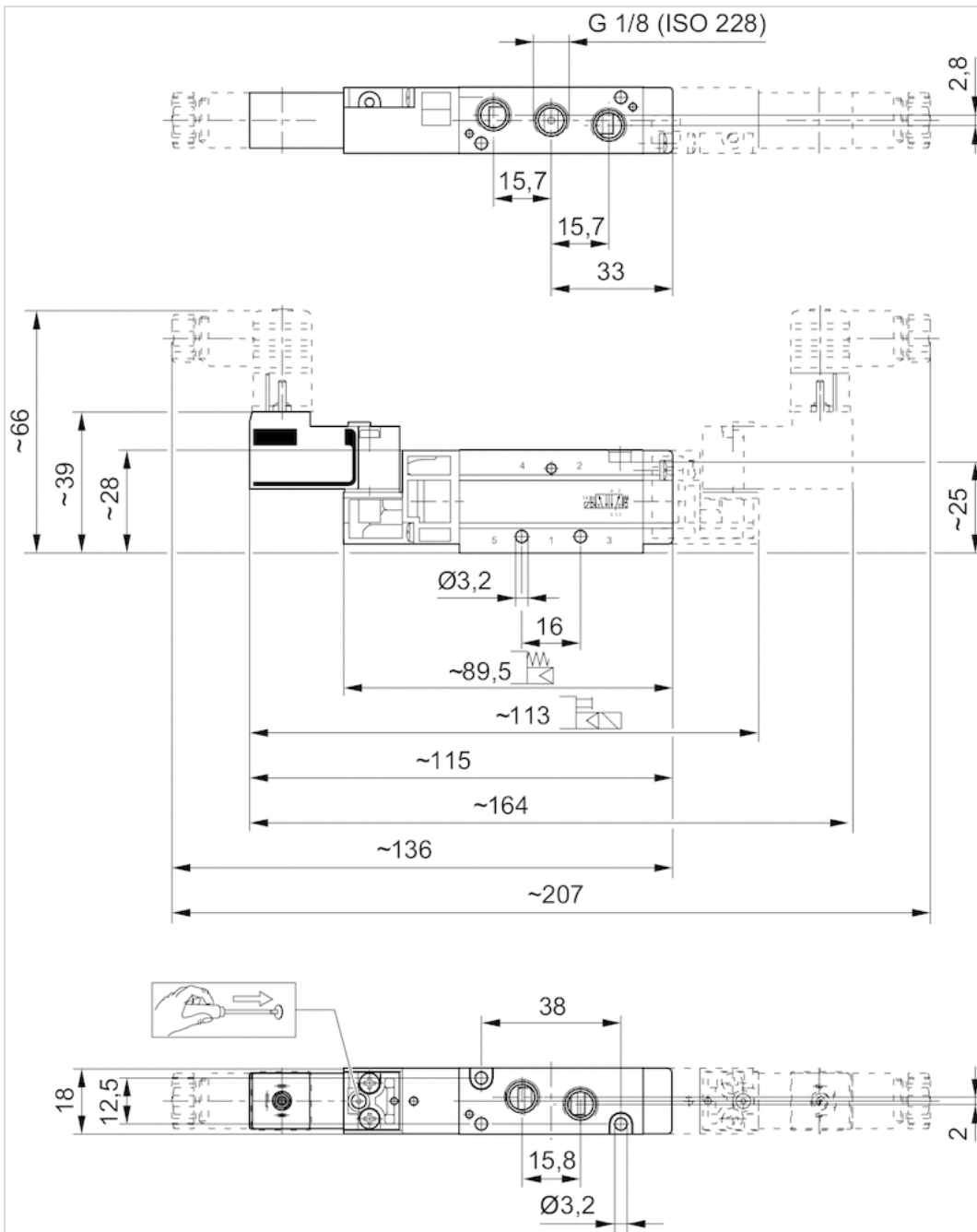





















5/2-directional valve, Series WV02

- 5/2
- Qn = 500 l/min
- Pilot valve width : 15 mm
- Pipe connection
- Compressed air connection output : G 1/8
- Electrical connection : Plug, ISO 15217, form C
- Manual override : with detent
- single solenoid double solenoid
- With spring/air spring return
- Pilot : Internal



Version	Spool valve, positive overlapping
Activation	Electrically
Pilot	Internal
Sealing principle	Soft sealing
Working pressure min./max.	See table below
Control pressure min./max.	See table below
Ambient temperature min./max.	0 ... 50 °C
Medium temperature min./max.	0 ... 60 °C
Medium	Compressed air
Max. particle size	5 µm
Oil content of compressed air	0 ... 5 mg/m ³
Nominal flow Qn	500 l/min
Connector standard	ISO 15217
Protection class with connection	IP65
Duty cycle	100 %
Mounting on manifold strip	PRS strip
mounting screws	M3
Weight	See table below

Technical data

Part No.		MO	Compressed air connection	
			Input	Output
0820038128			G 1/8	G 1/8
0820038126			G 1/8	G 1/8
0820038127			G 1/8	G 1/8
0820038129			G 1/8	G 1/8
0820038125			G 1/8	G 1/8
0820038628			G 1/8	G 1/8
0820038626			G 1/8	G 1/8
0820038627			G 1/8	G 1/8
0820038629			G 1/8	G 1/8
0820038625			G 1/8	G 1/8

Part No.	Operational voltage		Operational voltage
	DC	AC 50 Hz	AC 60 Hz
0820038128	-	24 V	24 V
0820038126	24 V	-	-
0820038127	24 V	-	-
0820038129	-	110 V	110 V
0820038125	-	230 V	230 V
0820038628	-	24 V	24 V
0820038626	24 V	-	-
0820038627	24 V	-	-
0820038629	-	110 V	110 V
0820038625	-	230 V	230 V

Part No.	Voltage tolerance	Voltage tolerance	Voltage tolerance	Power consumption
	DC	AC 50 Hz	AC 60 Hz	DC
0820038128	-	-10% / +10%	-10% / +10%	-
0820038126	-10% / +10%	-	-	2 W
0820038127	-10% / +10%	-	-	1 W
0820038129	-	-10% / +10%	-10% / +10%	-
0820038125	-	-10% / +10%	-10% / +10%	-
0820038628	-	-10% / +10%	-10% / +10%	-
0820038626	-10% / +10%	-	-	2 W
0820038627	-10% / +10%	-	-	1 W
0820038629	-	-10% / +10%	-10% / +10%	-
0820038625	-	-10% / +10%	-10% / +10%	-

Part No.	Holding power		Switch-on power	
	AC 50 Hz	AC 60 Hz	AC 50 Hz	AC 60 Hz
0820038128	1.6 VA	1.4 VA	2.2 VA	2 VA
0820038126	-	-	-	-
0820038127	-	-	-	-
0820038129	1.6 VA	1.4 VA	2.2 VA	2 VA
0820038125	1.6 VA	1.4 VA	2.2 VA	2 VA
0820038628	1.6 VA	1.4 VA	2.2 VA	2 VA
0820038626	-	-	-	-

Part No.	Holding power	Holding power	Switch-on power	Switch-on power
	AC 50 Hz	AC 60 Hz	AC 50 Hz	AC 60 Hz
0820038627	-	-	-	-
0820038629	1.6 VA	1.4 VA	2.2 VA	2 VA
0820038625	1.6 VA	1.4 VA	2.2 VA	2 VA

Part No.	Working pressure min./max.	Control pressure min./max.	Typ. switch-on time	Typ. switch-off time
0820038128	2 ... 10 bar	2 ... 10 bar	11 ms	14 ms
0820038126	2 ... 10 bar	2 ... 10 bar	11 ms	14 ms
0820038127	2 ... 10 bar	2 ... 10 bar	12 ms	16 ms
0820038129	2 ... 10 bar	2 ... 10 bar	11 ms	14 ms
0820038125	2 ... 10 bar	2 ... 10 bar	11 ms	14 ms
0820038628	1.5 ... 10 bar	1.5 ... 10 bar	8 ms	-
0820038626	1.5 ... 10 bar	1.5 ... 10 bar	8 ms	-
0820038627	1.5 ... 10 bar	1.5 ... 10 bar	10 ms	-
0820038629	1.5 ... 10 bar	1.5 ... 10 bar	8 ms	-
0820038625	1.5 ... 10 bar	1.5 ... 10 bar	8 ms	-

Part No.	Weight	
0820038128	0.11 kg	-
0820038126	0.11 kg	-
0820038127	0.11 kg	1)
0820038129	0.11 kg	-
0820038125	0.11 kg	-
0820038628	0.16 kg	-
0820038626	0.16 kg	-
0820038627	0.16 kg	1)
0820038629	0.16 kg	-
0820038625	0.16 kg	-

1) Low power consumption

Technical information

The min. control pressure must be adhered to, since otherwise faulty switching and valve failure may result!

The pressure dew point must be at least 15 °C under ambient and medium temperature and may not exceed 3 °C .

The oil content of compressed air must remain constant during the life cycle.

Use only the approved oils from AVENTICS. Further information can be found in the "Technical information" document (available in the MediaCentre).

Technical information

Material	
Housing	Aluminum, anodized
Seals	Hydrogenated acrylonitrile butadiene rubber
Front plate	Polyamide
Threaded bushing	Aluminum

Dimensions

Dimensions

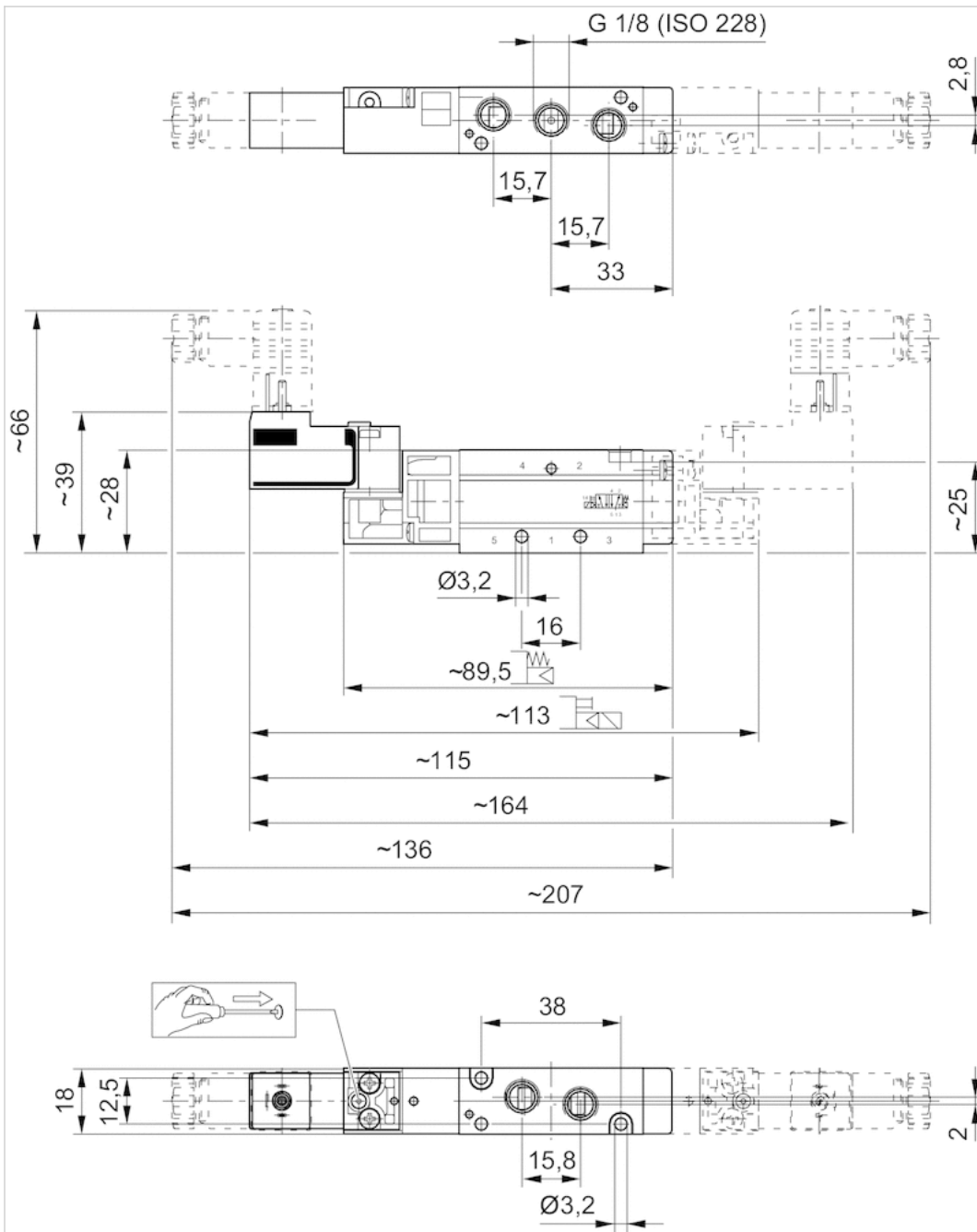













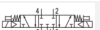





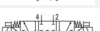



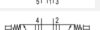



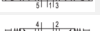

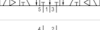

5/3-directional valve, Series WV02

- 5/3
- $Q_n = 250-400$ l/min
- Pilot valve width : 15 mm
- closed center exhausted center pressurized center
- Pipe connection
- Compressed air connection output : G 1/8
- Electrical connection : Plug, ISO 15217, form C
- Manual override : without detent
- Pilot : Internal

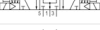

Version	Spool valve, positive overlapping
Activation	Electrically
Pilot	Internal
Sealing principle	Soft sealing
Working pressure min./max.	2.2 ... 10 bar
Control pressure min./max.	2.2 ... 10 bar
Ambient temperature min./max.	0 ... 50 °C
Medium temperature min./max.	0 ... 60 °C
Medium	Compressed air
Max. particle size	5 µm
Oil content of compressed air	0 ... 5 mg/m ³
Nominal flow Q_n	See table below
Connector standard	ISO 15217
Protection class with connection	IP65
Duty cycle	100 %
Mounting on manifold strip	PRS strip
mounting screws	M3
Weight	0.17 kg

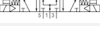
Technical data

Part No.		MO		Compressed air connection	
					Input
0820039018				closed center	G 1/8
0820039016				closed center	G 1/8
0820039017				closed center	G 1/8
0820039019				closed center	G 1/8
0820039015				closed center	G 1/8
0820039033				exhausted center	G 1/8
0820039031				exhausted center	G 1/8
0820039032				exhausted center	G 1/8
0820039034				exhausted center	G 1/8
0820039030				exhausted center	G 1/8
0820039063				pressurized center	G 1/8
0820039061				pressurized center	G 1/8
0820039062				pressurized center	G 1/8
0820039064				pressurized center	G 1/8
0820039060				pressurized center	G 1/8

Part No.	Compressed air connection		Operational voltage	
	Output		DC	AC 50 Hz
0820039018	G 1/8		-	24 V
0820039016	G 1/8		24 V	-
0820039017	G 1/8		24 V	-
0820039019	G 1/8		-	110 V
0820039015	G 1/8		-	230 V
0820039033	G 1/8		-	24 V
0820039031	G 1/8		24 V	-
0820039032	G 1/8		24 V	-
0820039034	G 1/8		-	110 V
0820039030	G 1/8		-	230 V
0820039063	G 1/8		-	24 V
0820039061	G 1/8		24 V	-
0820039062	G 1/8		24 V	-
0820039064	G 1/8		-	110 V
0820039060	G 1/8		-	230 V

Part No.	Operational voltage		Voltage tolerance	
	AC 60 Hz		DC	AC 50 Hz
0820039018	24 V		-	-10% / +10%
0820039016	-		-10% / +10%	-
0820039017	-		-10% / +10%	-
0820039019	110 V		-	-10% / +10%
0820039015	230 V		-	-10% / +10%
0820039033	24 V		-	-10% / +10%
0820039031	-		-10% / +10%	-
0820039032	-		-10% / +10%	-
0820039034	110 V		-	-10% / +10%

Part No.	Operational voltage	Voltage tolerance		Voltage tolerance	
		DC	AC 50 Hz	AC 60 Hz	AC 60 Hz
0820039030	230 V	-	-10% / +10%	-10% / +10%	-10% / +10%
0820039063	24 V	-	-10% / +10%	-10% / +10%	-10% / +10%
0820039061	-	-10% / +10%	-	-	-
0820039062	-	-10% / +10%	-	-	-
0820039064	110 V	-	-10% / +10%	-10% / +10%	-10% / +10%
0820039060	230 V	-	-10% / +10%	-10% / +10%	-10% / +10%

Part No.	Power consumption		Holding power		Switch-on power	
	DC	AC 50 Hz	AC 50 Hz	AC 60 Hz	AC 50 Hz	AC 50 Hz
0820039018	-	1.6 VA	1.6 VA	1.4 VA	2.2 VA	2.2 VA
0820039016	2 W	-	-	-	-	-
0820039017	1 W	-	-	-	-	-
0820039019	-	1.6 VA	1.6 VA	1.4 VA	2.2 VA	2.2 VA
0820039015	-	1.6 VA	1.6 VA	1.4 VA	2.2 VA	2.2 VA
0820039033	-	1.6 VA	1.6 VA	1.4 VA	2.2 VA	2.2 VA
0820039031	2 W	-	-	-	-	-
0820039032	1 W	-	-	-	-	-
0820039034	-	1.6 VA	1.6 VA	1.4 VA	2.2 VA	2.2 VA
0820039030	-	1.6 VA	1.6 VA	1.4 VA	2.2 VA	2.2 VA
0820039063	-	1.6 VA	1.6 VA	1.4 VA	2.2 VA	2.2 VA
0820039061	2 W	-	-	-	-	-
0820039062	1 W	-	-	-	-	-
0820039064	-	1.6 VA	1.6 VA	1.4 VA	2.2 VA	2.2 VA
0820039060	-	1.6 VA	1.6 VA	1.4 VA	2.2 VA	2.2 VA

Part No.	Switch-on power		Nominal flow Q _n	Typ. switch-on time	Typ. switch-off time	
	DC	AC 60 Hz			DC	AC 60 Hz
0820039018	-	2 VA	400 l/min	9 ms	20 ms	-
0820039016	-	-	400 l/min	9 ms	20 ms	-
0820039017	-	-	400 l/min	11 ms	23 ms	1)
0820039019	-	2 VA	400 l/min	9 ms	20 ms	-
0820039015	-	2 VA	400 l/min	9 ms	20 ms	-
0820039033	-	2 VA	250 l/min	9 ms	20 ms	-
0820039031	-	-	250 l/min	9 ms	20 ms	-
0820039032	-	-	250 l/min	11 ms	23 ms	1)
0820039034	-	2 VA	250 l/min	9 ms	20 ms	-
0820039030	-	2 VA	250 l/min	9 ms	20 ms	-
0820039063	-	2 VA	250 l/min	9 ms	20 ms	-
0820039061	-	-	250 l/min	9 ms	20 ms	-
0820039062	-	-	250 l/min	11 ms	23 ms	1)
0820039064	-	2 VA	250 l/min	9 ms	20 ms	-
0820039060	-	2 VA	250 l/min	9 ms	20 ms	-

1) Low power consumption

Technical information

The min. control pressure must be adhered to, since otherwise faulty switching and valve failure may result!

The pressure dew point must be at least 15 °C under ambient and medium temperature and may not exceed 3 °C .

The oil content of compressed air must remain constant during the life cycle.

Use only the approved oils from AVENTICS. Further information can be found in the "Technical information" document (available in the MediaCentre).

Technical information

Material	
Housing	Aluminum, anodized
Seals	Hydrogenated acrylonitrile butadiene rubber
Front plate	Polyamide
Threaded bushing	Aluminum

Dimensions

Dimensions

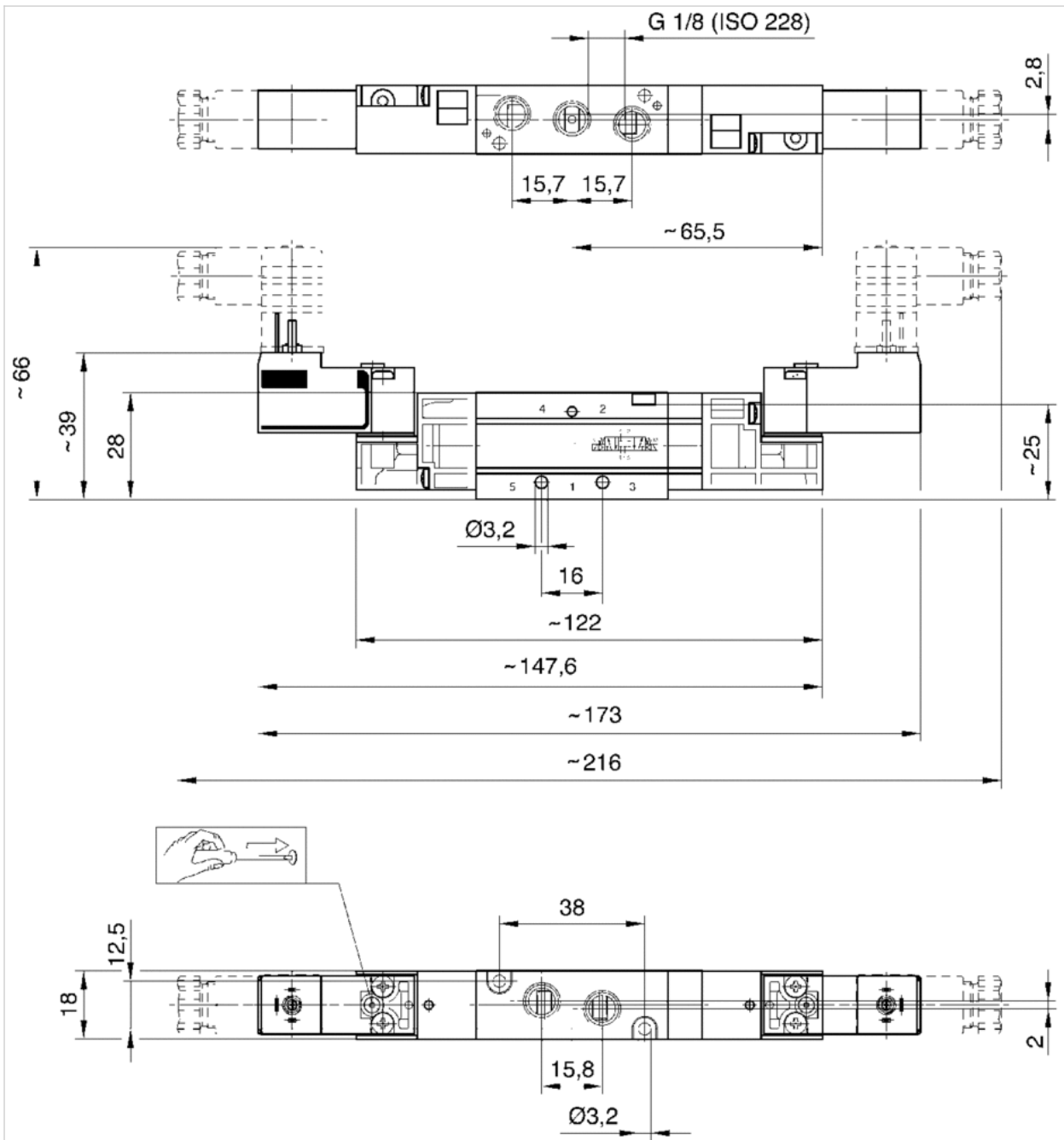











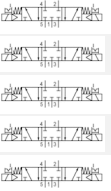
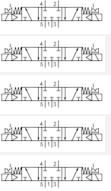

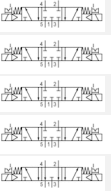

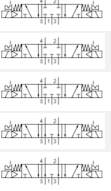

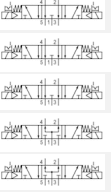

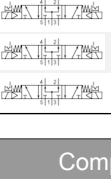

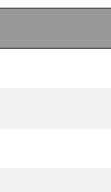

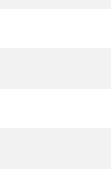
5/3-directional valve, Series WV02

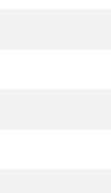
- 5/3
- Qn = 250-400 l/min
- Pilot valve width : 15 mm
- closed center exhausted center pressurized center
- Pipe connection
- Compressed air connection output : G 1/8
- Electrical connection : Plug, ISO 15217, form C
- Manual override : with detent
- double solenoid
- Pilot : Internal

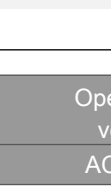

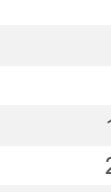
Version	Spool valve, positive overlapping
Activation	Electrically
Pilot	Internal
Sealing principle	Soft sealing
Working pressure min./max.	2.2 ... 10 bar
Control pressure min./max.	2.2 ... 10 bar
Ambient temperature min./max.	0 ... 50 °C
Medium temperature min./max.	0 ... 60 °C
Medium	Compressed air
Max. particle size	0.5 µm
Oil content of compressed air	0 ... 25 mg/m ³
Nominal flow Qn	See table below
Connector standard	ISO 15217
Protection class with connection	IP65
Duty cycle	100 %
Mounting on manifold strip	PRS strip
mounting screws	M3
Weight	0.17 kg

Technical data

Part No.		MO	Compressed air connection	
				Input
0820039118			closed center	G 1/8
0820039116			closed center	G 1/8
0820039117			closed center	G 1/8
0820039119			closed center	G 1/8
0820039115			closed center	G 1/8
0820039133			exhausted center	G 1/8
0820039131			exhausted center	G 1/8
0820039132			exhausted center	G 1/8
0820039134			exhausted center	G 1/8
0820039130			exhausted center	G 1/8
0820039163			pressurized center	G 1/8
0820039161			pressurized center	G 1/8
0820039162			pressurized center	G 1/8
0820039164			pressurized center	G 1/8
0820039160			pressurized center	G 1/8

Part No.	Compressed air connection		Operational voltage	Operational voltage
	Output		DC	AC 50 Hz
0820039118	G 1/8		-	24 V
0820039116	G 1/8		24 V	-
0820039117	G 1/8		24 V	-
0820039119	G 1/8		-	110 V
0820039115	G 1/8		-	230 V
0820039133	G 1/8		-	24 V
0820039131	G 1/8		24 V	-
0820039132	G 1/8		24 V	-
0820039134	G 1/8		-	110 V
0820039130	G 1/8		-	230 V
0820039163	G 1/8		-	24 V
0820039161	G 1/8		24 V	-
0820039162	G 1/8		24 V	-
0820039164	G 1/8		-	110 V
0820039160	G 1/8		-	230 V

Part No.	Operational voltage	Voltage tolerance		Voltage tolerance
	AC 60 Hz	DC	AC 50 Hz	AC 60 Hz
0820039118	24 V	-	-10% / +10%	-10% / +10%
0820039116	-	-10% / +10%	-	-
0820039117	-	-10% / +10%	-	-
0820039119	110 V	-	-10% / +10%	-10% / +10%
0820039115	230 V	-	-10% / +10%	-10% / +10%
0820039133	24 V	-	-10% / +10%	-10% / +10%
0820039131	-	-10% / +10%	-	-
0820039132	-	-10% / +10%	-	-
0820039134	110 V	-	-10% / +10%	-10% / +10%

Part No.	Operational voltage	Voltage tolerance		
		DC	AC 50 Hz	AC 60 Hz
0820039130	230 V	-	-10% / +10%	-10% / +10%
0820039163	24 V	-	-10% / +10%	-10% / +10%
0820039161	-	-10% / +10%	-	-
0820039162	-	-10% / +10%	-	-
0820039164	110 V	-	-10% / +10%	-10% / +10%
0820039160	230 V	-	-10% / +10%	-10% / +10%

Part No.	Power consumption		Holding power		Switch-on power
	DC	AC 50 Hz	AC 50 Hz	AC 60 Hz	AC 50 Hz
0820039118	-	1.6 VA	1.6 VA	1.4 VA	2.2 VA
0820039116	2 W	-	-	-	-
0820039117	1 W	-	-	-	-
0820039119	-	1.6 VA	1.6 VA	1.4 VA	2.2 VA
0820039115	-	1.6 VA	1.6 VA	1.4 VA	2.2 VA
0820039133	-	1.6 VA	1.6 VA	1.4 VA	2.2 VA
0820039131	2 W	-	-	-	-
0820039132	1 W	-	-	-	-
0820039134	-	1.6 VA	1.6 VA	1.4 VA	2.2 VA
0820039130	-	1.6 VA	1.6 VA	1.4 VA	2.2 VA
0820039163	-	1.6 VA	1.6 VA	1.4 VA	2.2 VA
0820039161	2 W	-	-	-	-
0820039162	1 W	-	-	-	-
0820039164	-	1.6 VA	1.6 VA	1.4 VA	2.2 VA
0820039160	-	1.6 VA	1.6 VA	1.4 VA	2.2 VA

Part No.	Switch-on power	Nominal flow Q _n	Typ. switch-on time	Typ. switch-off time	
	AC 60 Hz				
0820039118	2 VA	400 l/min	9 ms	20 ms	-
0820039116	-	400 l/min	9 ms	20 ms	-
0820039117	-	400 l/min	11 ms	23 ms	1)
0820039119	2 VA	400 l/min	9 ms	20 ms	-
0820039115	2 VA	400 l/min	9 ms	20 ms	-
0820039133	2 VA	250 l/min	9 ms	20 ms	-
0820039131	-	250 l/min	9 ms	20 ms	-
0820039132	-	250 l/min	11 ms	23 ms	1)
0820039134	2 VA	250 l/min	9 ms	20 ms	-
0820039130	2 VA	250 l/min	9 ms	20 ms	-
0820039163	2 VA	250 l/min	9 ms	20 ms	-
0820039161	-	250 l/min	9 ms	20 ms	-
0820039162	-	250 l/min	11 ms	23 ms	1)
0820039164	2 VA	250 l/min	9 ms	20 ms	-
0820039160	2 VA	250 l/min	9 ms	20 ms	-

1) Low power consumption

Technical information

The min. control pressure must be adhered to, since otherwise faulty switching and valve failure may result!

The pressure dew point must be at least 15 °C under ambient and medium temperature and may not exceed 3 °C .

The oil content of compressed air must remain constant during the life cycle.

Use only the approved oils from AVENTICS. Further information can be found in the "Technical information" document (available in the MediaCentre).

Technical information

Material	
Housing	Aluminum
Seals	Acrylonitrile butadiene rubber
Front plate	Polyamide
Threaded bushing	Aluminum

Dimensions

Dimensions

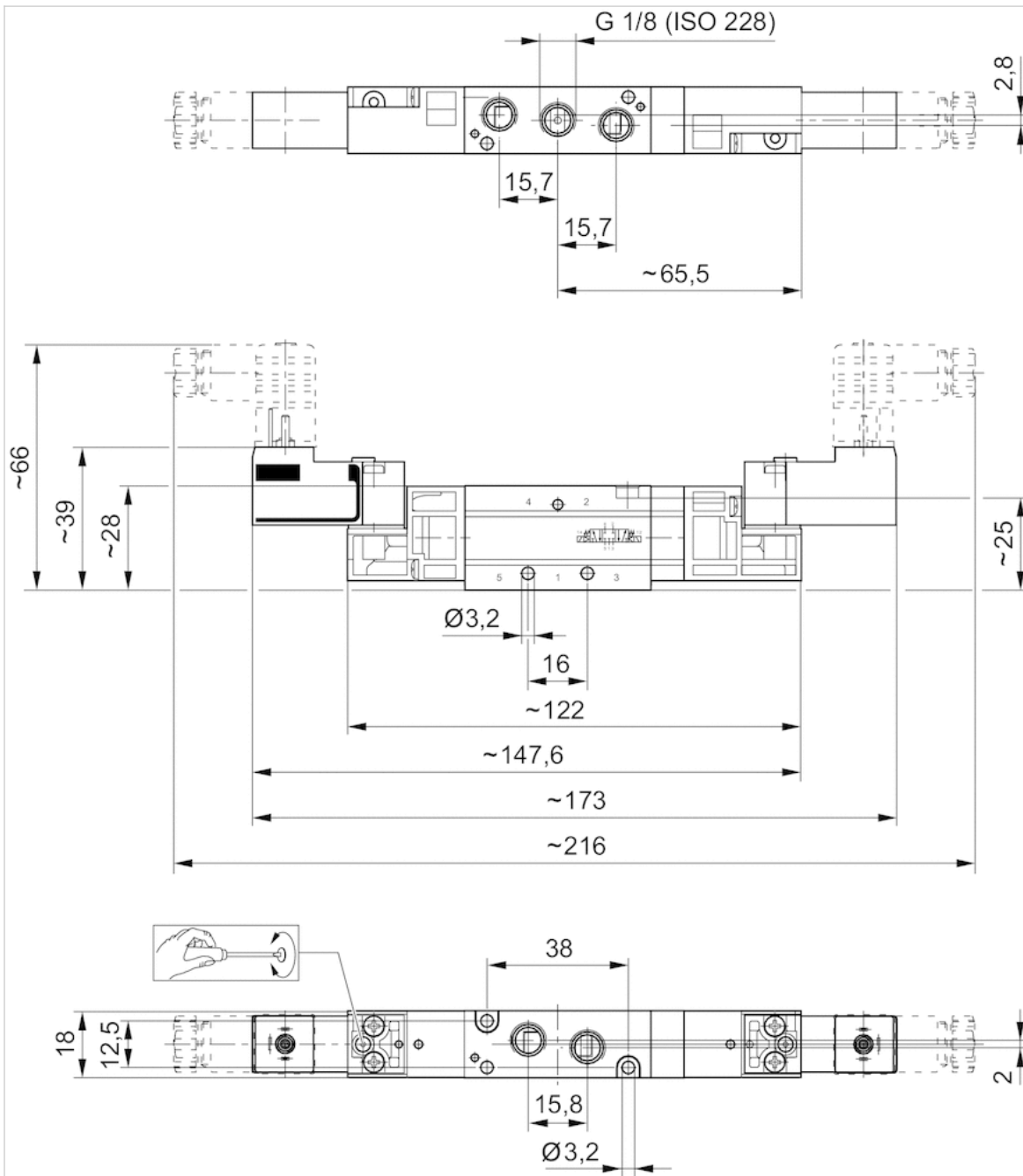



5/2-directional valve, Series WV02

- Qn = 500 l/min
- Compressed air connection output G 1/8
- Pipe connection



Version	Spool valve, positive overlapping
Activation	pneumatically
Pilot	External
Sealing principle	Soft sealing
Flow rate value Qn	500 l/min
Working pressure min./max.	See table below
Control pressure min./max.	See table below
Ambient temperature min./max.	0 ... 80 °C
Medium temperature min./max.	0 ... 80 °C
Medium	Compressed air
Max. particle size	5 µm
Oil content of compressed air	0 ... 5 mg/m ³
Mounting on manifold strip	PRS strip
Mounting screw	M3
Weight	See table below

Technical data

Part No.		Compressed air connection	
		Input	Output
0820238001		G 1/8	G 1/8
0820238002		G 1/8	G 1/8

Part No.	Working pressure min./max.	Control pressure min./max.	Weight	
0820238001	2 ... 10 bar	10 bar	0.08 kg	1)
0820238002	-0.9 ... 10 bar	1.5 ... 10 bar	0.1 kg	-

1) See diagram

Technical information

The min. control pressure must be adhered to, since otherwise faulty switching and valve failure may result!
 The pressure dew point must be at least 15 °C under ambient and medium temperature and may not exceed 3 °C .
 The oil content of compressed air must remain constant during the life cycle.
 Use only the approved oils from AVENTICS. Further information can be found in the "Technical information" document (available in the MediaCentre).

Technical information

Material	
Housing	Aluminum, anodized
Seals	Acrylonitrile butadiene rubber Hydrogenated nitrile butadiene rubber

Material	
Front plate	Polyamide
Threaded bushing	Aluminum

Dimensions

Dimensions

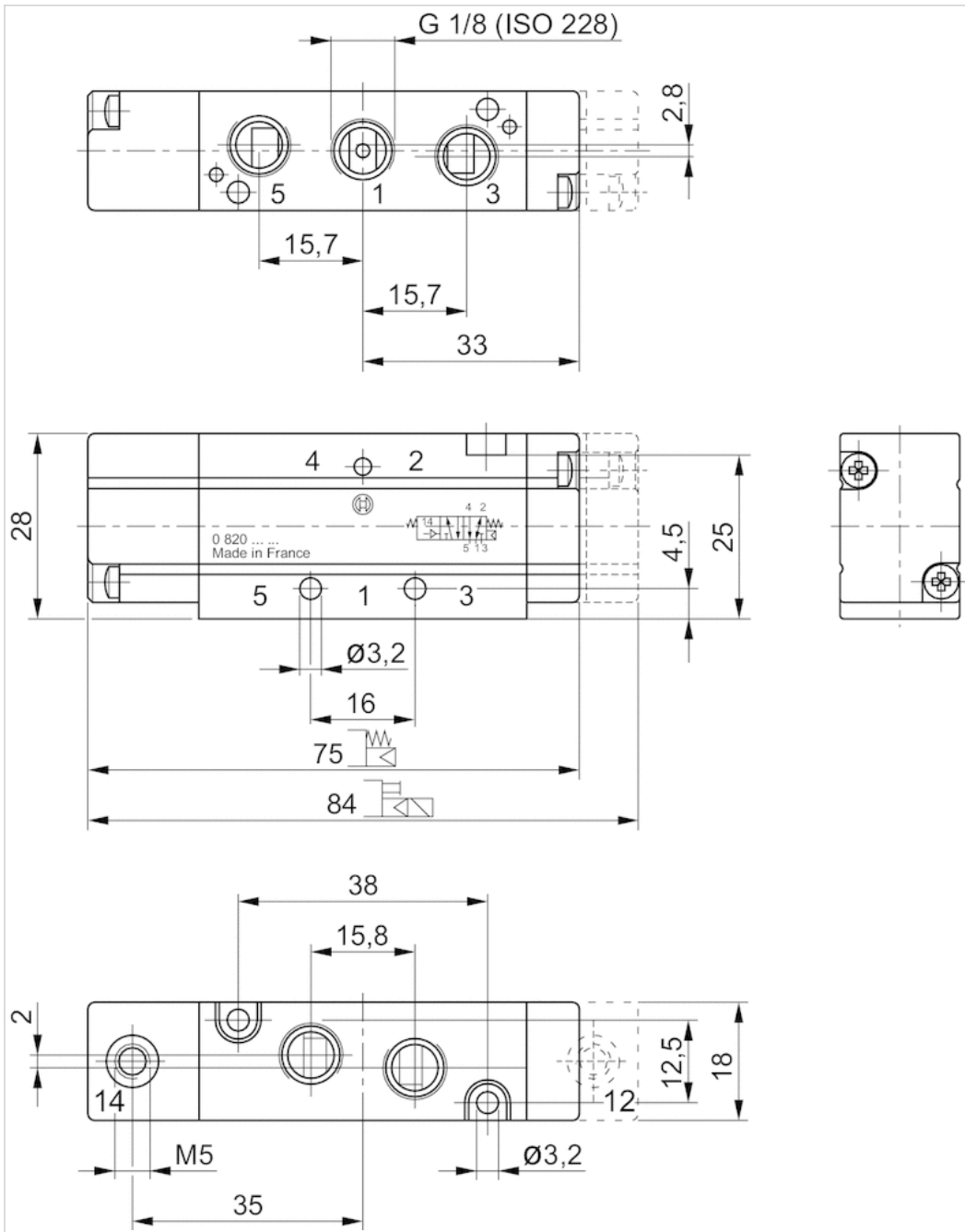

Diagrams

Control pressure

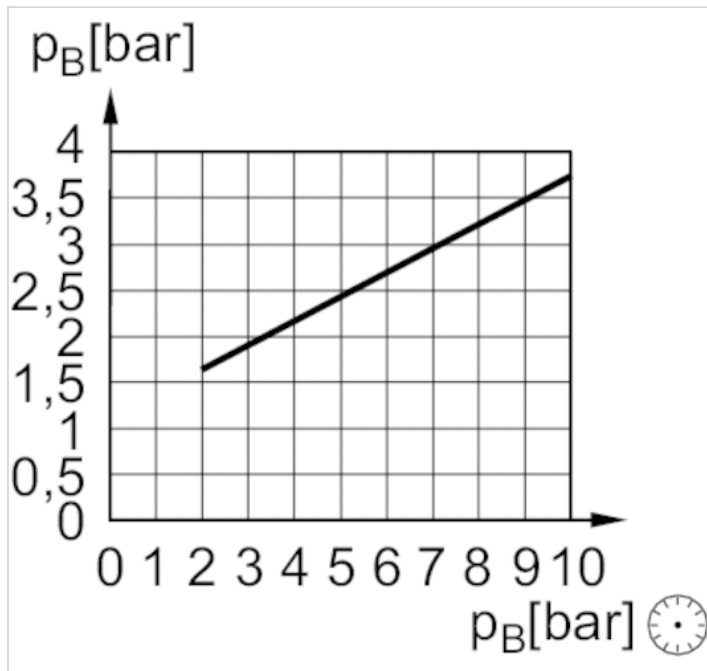

p_e = external control pressure, min.

p_B = Working pressure



5/3-directional valve, Series WV02

- Qn = 250-400 l/min
- Compressed air connection output G 1/8
- double air pilot
- Pipe connection



Version	Spool valve, positive overlapping
Activation	pneumatically
Pilot	External
Sealing principle	Soft sealing
Working pressure min./max.	-0.9 ... 10 bar
Control pressure min./max.	2.2 ... 10 bar
Ambient temperature min./max.	0 ... 80 °C
Medium temperature min./max.	0 ... 80 °C
Medium	Compressed air
Max. particle size	5 µm
Oil content of compressed air	0 ... 5 mg/m ³
Mounting on manifold strip	PRS strip
Mounting screw	M3
Weight	0.11 kg

Technical data

Part No.			Compressed air connection	
				Input
0820239001		closed center		G 1/8
0820239002		exhausted center		G 1/8
0820239003		pressurized center		G 1/8

Part No.	Compressed air connection		Flow
		Output	Qn
0820239001		G 1/8	400 l/min
0820239002		G 1/8	250 l/min
0820239003		G 1/8	250 l/min

Technical information

The min. control pressure must be adhered to, since otherwise faulty switching and valve failure may result!
 The pressure dew point must be at least 15 °C under ambient and medium temperature and may not exceed 3 °C .
 The oil content of compressed air must remain constant during the life cycle.
 Use only the approved oils from AVENTICS. Further information can be found in the "Technical information" document (available in the MediaCentre).

Technical information

Material	
Housing	Aluminum, anodized
Seals	Acrylonitrile butadiene rubber Hydrogenated nitrile butadiene rubber

Material	
Front plate	Polyamide
Threaded bushing	Aluminum

Dimensions

Dimensions

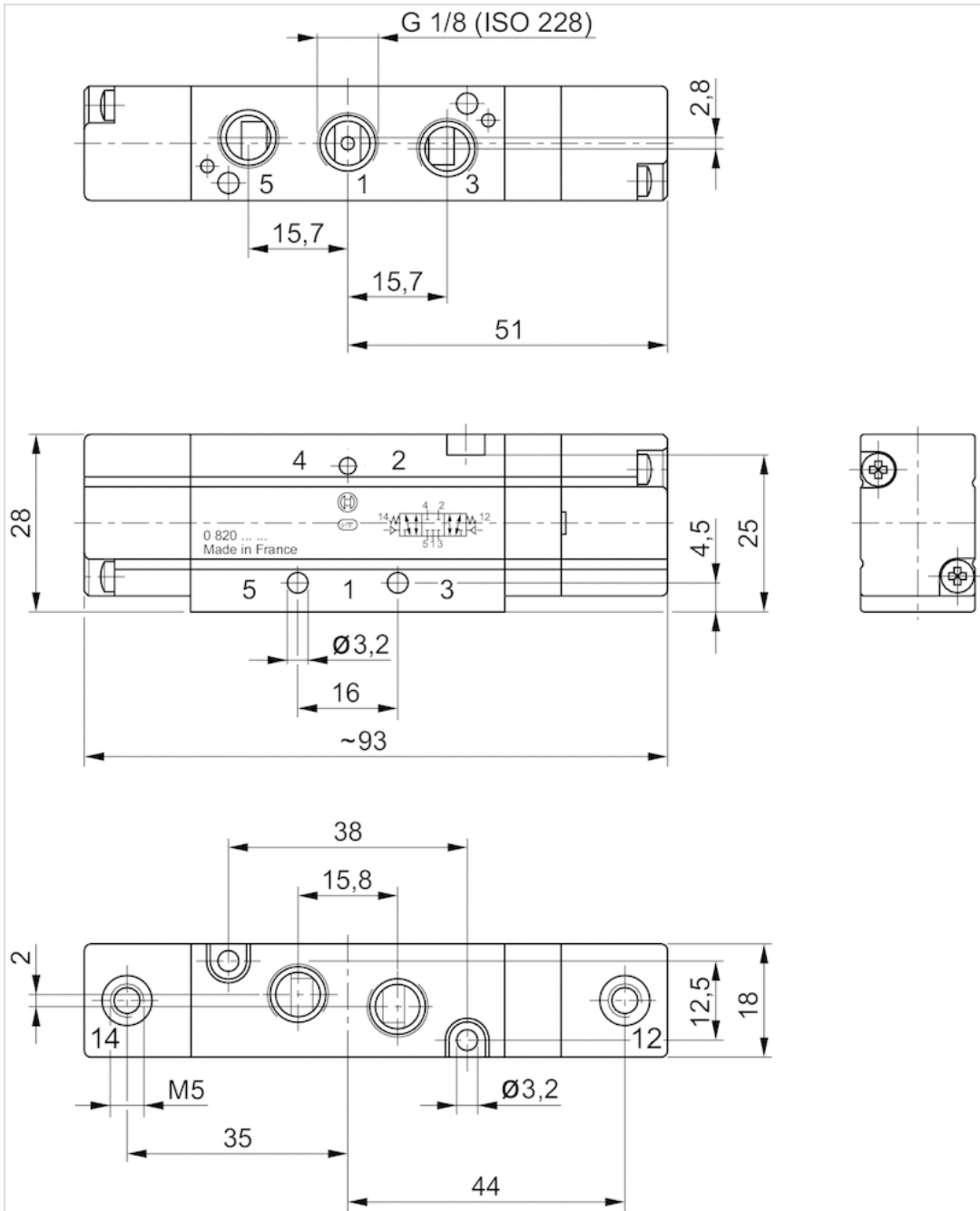



Valve plug connector, series CON-VP

- Socket, form C, 2+E, angled, 90°
- ISO 15217
- unshielded
- with LED Green



Connection type	Screws
Ambient temperature min./max.	-40 ... 90 °C
Operational voltage	See table below
Protection class	IP65
Mounting screw tightening torque	0.4 Nm
Weight	See table below

Technical data

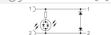
Part No.		Operational voltage	Max. current	Protective circuit	Contact assignment
1834484187		250 / 300 V AC/DC	6 A	-	2+E
8941012202		250 / 300 V AC/DC	6 A	-	2+E
4402050330		24 V AC/DC	-	Z-diode	2+E

Part No.	LED status display	suitable cable-Ø min./max	Seal	Weight
1834484187	-	4 / 8 mm	caoutchouc/butadiene caoutchouc	0.012 kg
8941012202	-	4 / 8 mm	-	0.012 kg
4402050330	Green	-	-	0.014 kg

Part No.	Fig.	
1834484187	Fig. 1	-
8941012202	Fig. 2	-
4402050330	Fig. 3	1)

1)

Technical information

The specified protection class is only valid in assembled and tested state.

Technical information

Material

Seals

caoutchouc/butadiene caoutchouc

Dimensions

Fig. 1

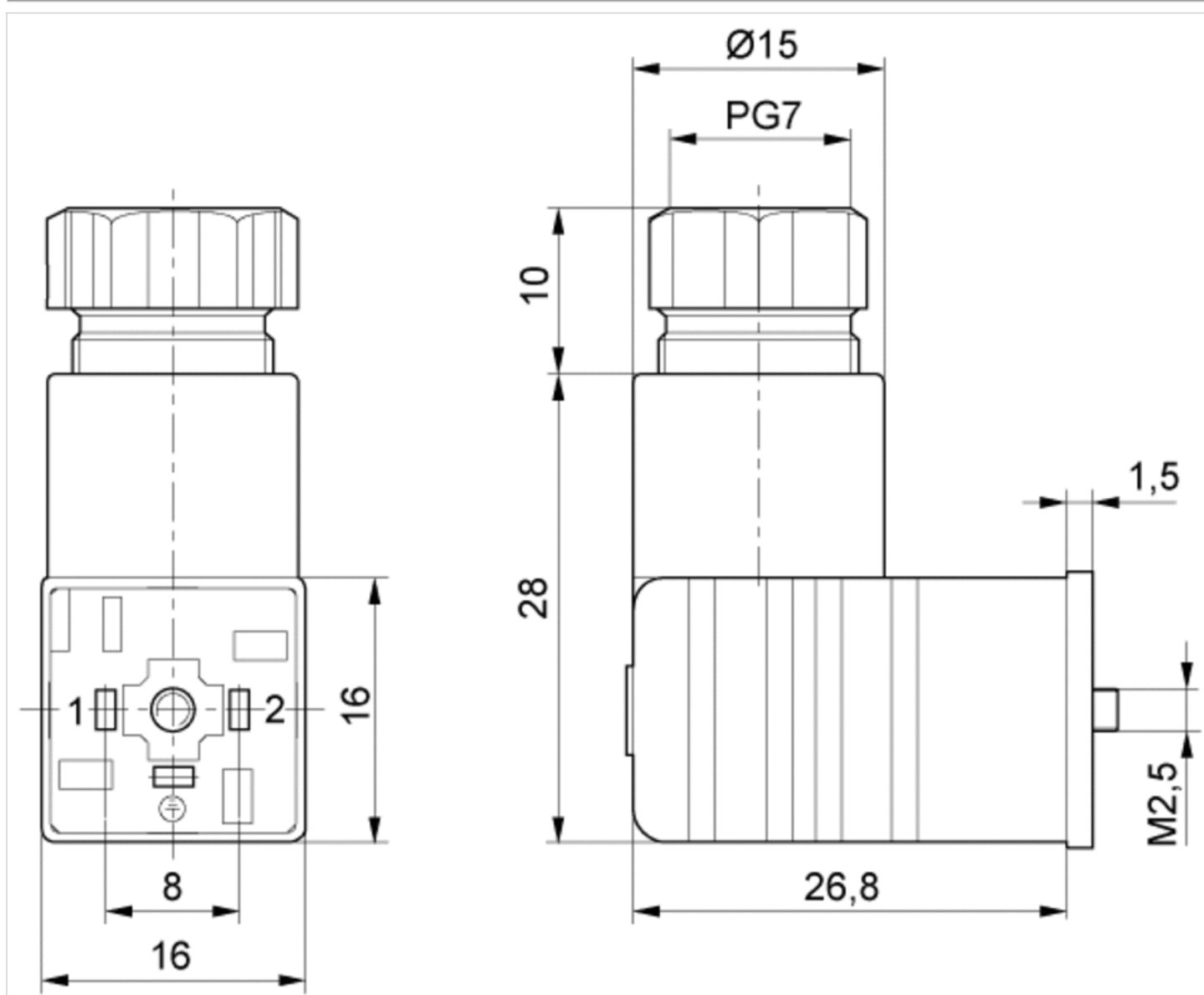

Fig. 2

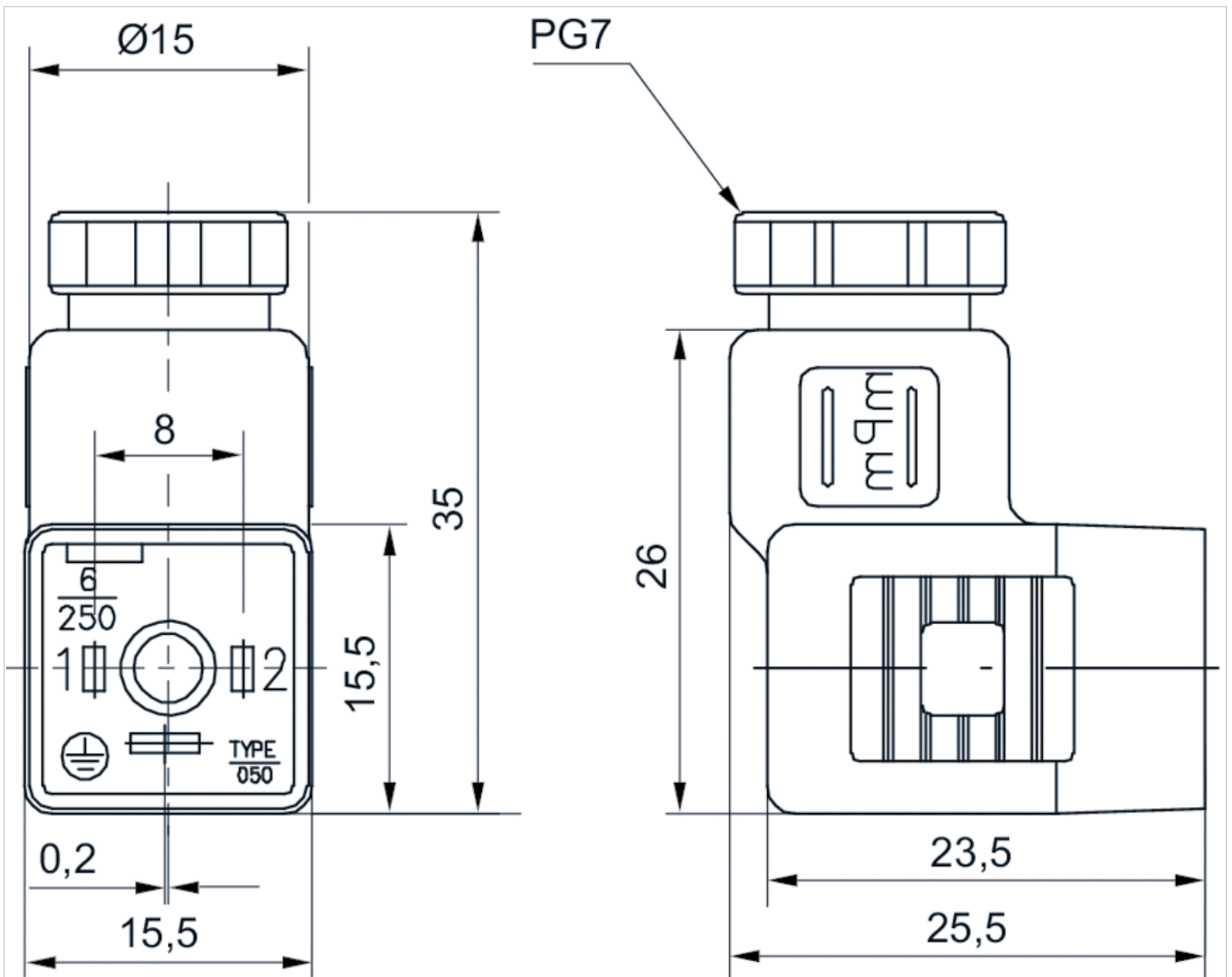
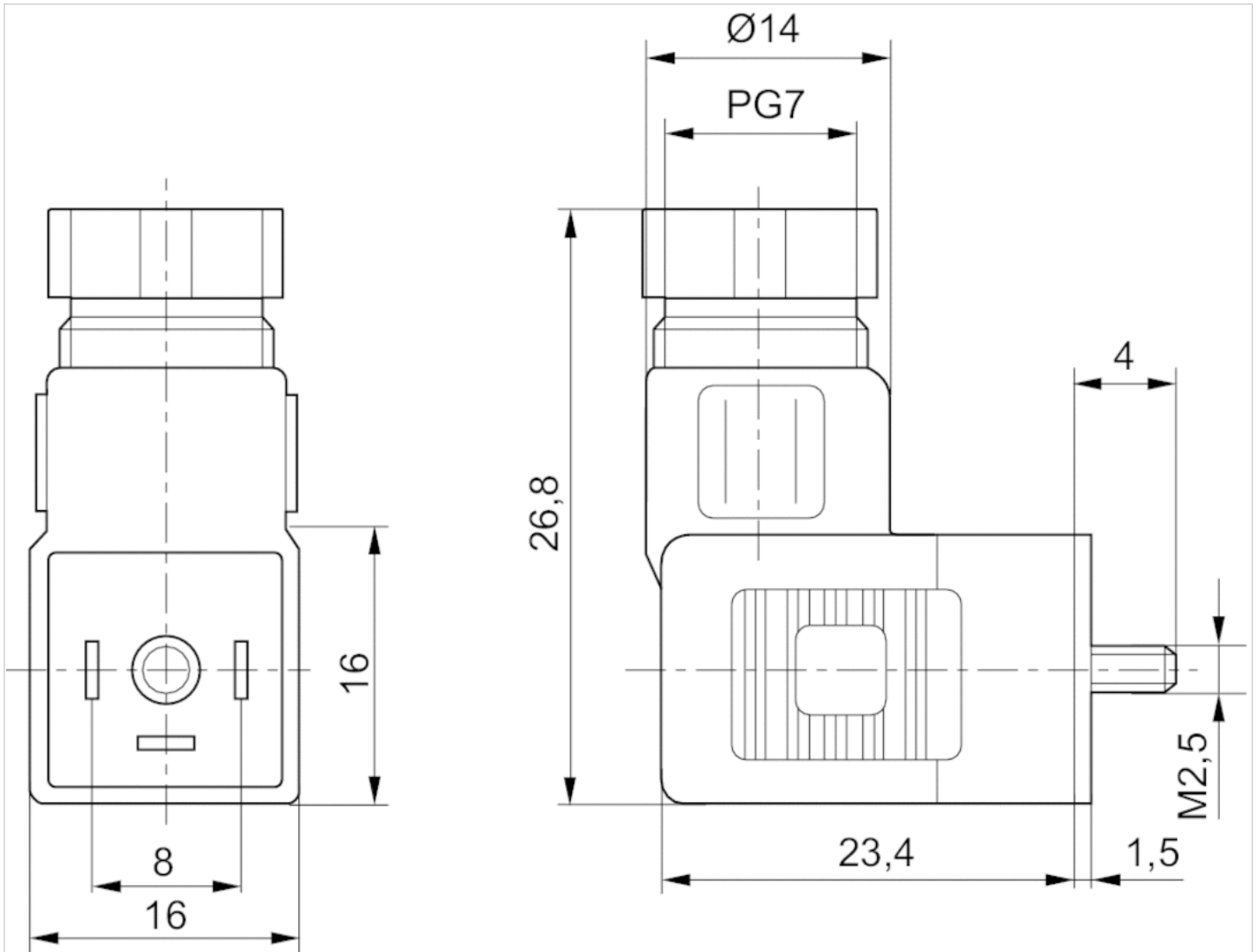

Fig. 3



Valve plug connector, series CON-VP

- Socket form C 2+E angled 90°
- open cable ends 3-pin
- with cable
- unshielded



Ambient temperature min./max.	-20 ... 80 °C
Operational voltage	See table below
Protection class	IP67
Wire cross-section	0.75 mm ²
Mounting screw tightening torque	0.4 Nm
Weight	See table below

Technical data

Part No.		Operational voltage	Max. current	Protective circuit	Contact assignment
1834484212		230 V AC/DC	6 A	-	2+E
1834484213		230 V AC/DC	6 A	-	2+E
1834484214		230 V AC/DC	6 A	-	2+E
1834484215		230 V AC/DC	6 A	-	2+E
1834484204		24 V AC/DC	6 A	Z-diode	2+E
1834484205		24 V AC/DC	6 A	Z-diode	2+E
1834484206		24 V AC/DC	6 A	Z-diode	2+E
1834484207		24 V AC/DC	6 A	Z-diode	2+E
1834484208		230 V AC/DC	6 A	Varistor	2+E
1834484209		230 V AC/DC	6 A	Varistor	2+E
1834484210		230 V AC/DC	6 A	Varistor	2+E
1834484211		230 V AC/DC	6 A	Varistor	2+E
1834484236		24 V AC/DC	6 A	Z-diode	2+E

Part No.	LED status display	Number of wires	Cable-Ø	Cable length	Weight	Fig.	
1834484212	-	3	5.9 mm	3 m	0.183 kg	Fig. 1	-
1834484213	-	3	5.9 mm	3 m	0.183 kg	Fig. 2	-
1834484214	-	3	5.9 mm	5 m	0.308 kg	Fig. 1	-
1834484215	-	3	5.9 mm	5 m	0.308 kg	Fig. 2	-
1834484204	Yellow	3	5.9 mm	3 m	0.185 kg	Fig. 1	1)
1834484205	Yellow	3	5.9 mm	3 m	0.185 kg	Fig. 2	1)
1834484206	Yellow	3	5.9 mm	5 m	0.292 kg	Fig. 1	1)
1834484207	Yellow	3	5.9 mm	5 m	0.298 kg	Fig. 2	1)
1834484208	Yellow	3	5.9 mm	3 m	0.171 kg	Fig. 1	1)
1834484209	Yellow	3	5.9 mm	3 m	0.194 kg	Fig. 2	1)
1834484210	Yellow	3	5.9 mm	5 m	0.297 kg	Fig. 1	1)

Part No.	LED status display	Number of wires	Cable-Ø	Cable length	Weight	Fig.	
1834484211	Yellow	3	5.9 mm	5 m	0.285 kg	Fig. 2	1)
1834484236	Yellow	3	5.9 mm	10 m	0.571 kg	Fig. 2	1)

1) Scope of delivery incl. flat gasket

Technical information

The specified protection class is only valid in assembled and tested state.

Technical information

Material	
Seals	caoutchouc/butadiene caoutchouc
Cable sheath	Polyvinyl chloride

Dimensions

Fig. 1

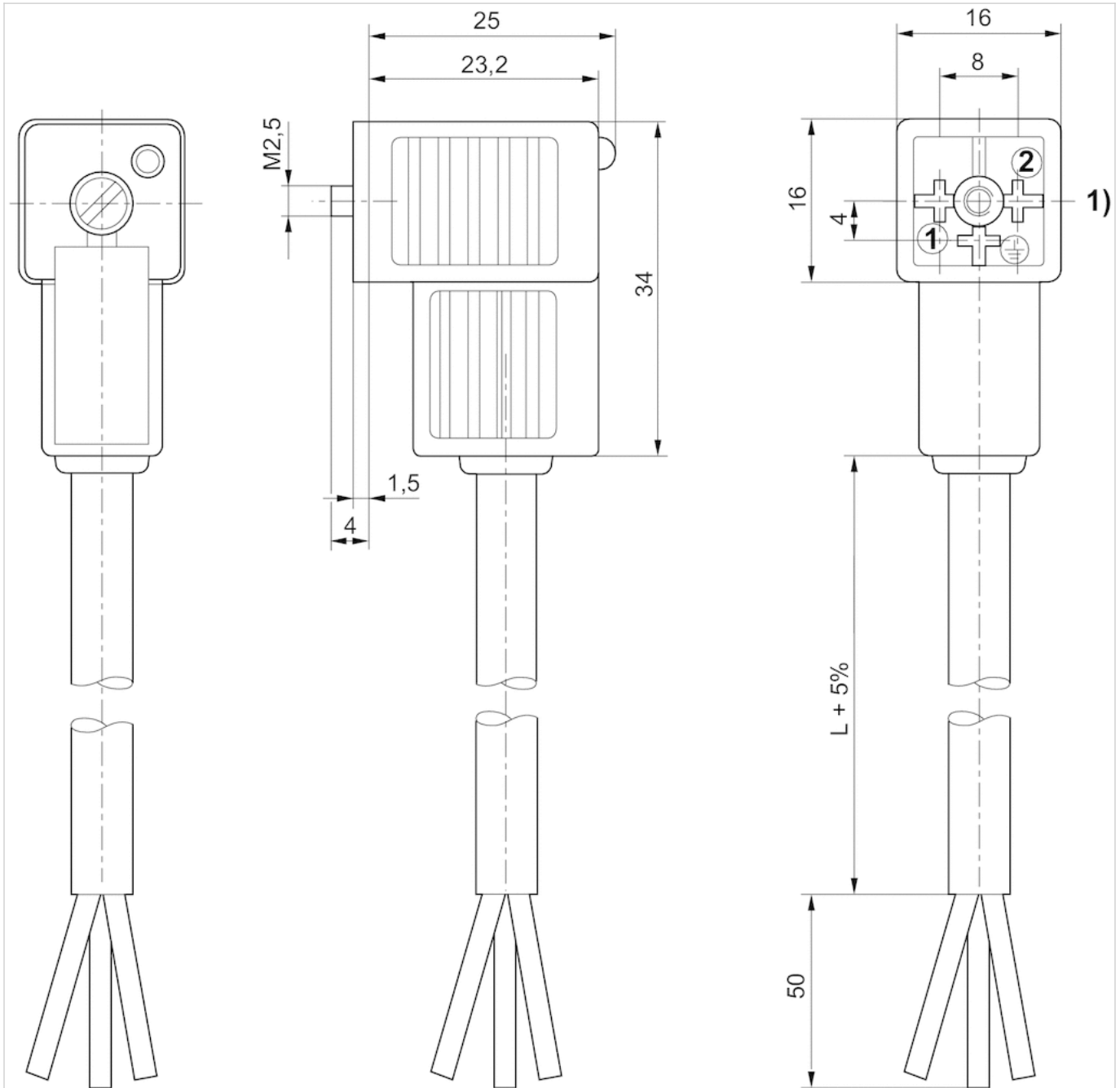

1) 0° female insert

Fig. 2

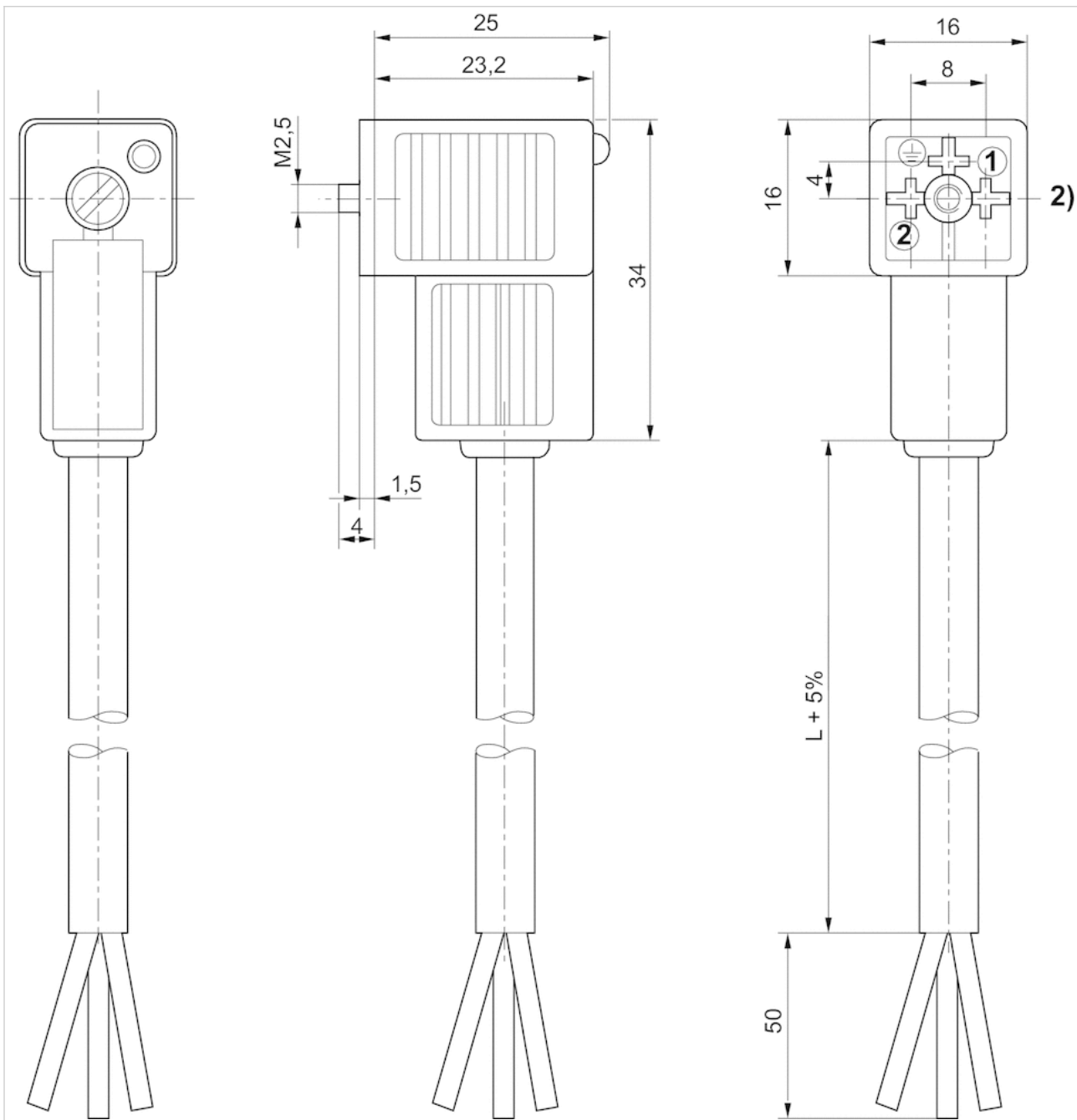

2) 180° female insert























3/2-directional valve, Series DO16

- 3/2
- Plate connection
- Electrical connection : Plug, ISO 15217, form C
- Manual override : without detent with detent
- With spring return



Version	Poppet valve
Activation	Electrically
Sealing principle	Soft sealing
Working pressure min./max.	See table below
Ambient temperature min./max.	-10 ... 50 °C
Medium temperature min./max.	-10 ... 50 °C
Medium	Compressed air
Max. particle size	5 µm
Oil content of compressed air	0 ... 5 mg/m ³
Nominal flow 1 ▶ 2	See table below
Nominal flow 2 ▶ 3	See table below
Protection class acc. to DIN EN 61140	Class I
Electrically	
Protection class with connection	IP65
Duty cycle	100 %
Mounting on manifold strip	PRS strip
mounting screws	M3
Weight	0.035 kg

Technical data

Part No.		MO	Operational voltage	
			DC	AC 50 Hz
0820048002			24 V	-
0820048004			-	24 V
0820048005			-	-
0820048001			-	230 V
0820048026			24 V	-
0820048028			-	24 V
0820048101			-	230 V
0820048029			-	-
0820048025			-	230 V
0820048102			24 V	-
0820048126			24 V	-

Part No.	Operational voltage	Voltage tolerance		
		DC	AC 50 Hz	AC 60 Hz
0820048002	-	-10% / +15%	-	-
0820048004	-	-	-10% / +15%	-
0820048005	110 V	-	-	-10% / +15%
0820048001	-	-	-10% / +15%	-

Part No.	Operational voltage	Voltage tolerance	Voltage tolerance	Voltage tolerance
		DC	AC 50 Hz	AC 60 Hz
0820048026	-	-10% / +15%	-	-
0820048028	-	-	-10% / +15%	-
0820048101	-	-	-10% / +15%	-
0820048029	110 V	-	-	-10% / +15%
0820048025	-	-	-10% / +15%	-
0820048102	-	-10% / +15%	-	-
0820048126	-	-10% / +15%	-	-

Part No.	Power consumption	Holding power	Holding power	Switch-on power
	DC	AC 50 Hz	AC 60 Hz	AC 50 Hz
0820048002	2 W	-	-	-
0820048004	-	1.6 VA	-	2.2 VA
0820048005	-	-	1.4 VA	-
0820048001	-	1.6 VA	-	2.2 VA
0820048026	2 W	-	-	-
0820048028	-	1.6 VA	-	2.2 VA
0820048101	-	1.6 VA	-	2.2 VA
0820048029	-	-	1.4 VA	-
0820048025	-	1.6 VA	-	2.2 VA
0820048102	2 W	-	-	-
0820048126	2 W	-	-	-

Part No.	Switch-on power	Nominal flow 1 ▶ 2	Nominal flow 2 ▶ 3	Working pressure min./max.
	AC 60 Hz			
0820048002	-	25 l/min	36 l/min	0 ... 10 bar
0820048004	-	25 l/min	36 l/min	0 ... 10 bar
0820048005	2 VA	25 l/min	36 l/min	0 ... 10 bar
0820048001	-	25 l/min	36 l/min	0 ... 10 bar
0820048026	-	25 l/min	36 l/min	0 ... 10 bar
0820048028	-	25 l/min	36 l/min	0 ... 10 bar
0820048101	-	16 l/min	19 l/min	0 ... 6 bar
0820048029	2 VA	25 l/min	36 l/min	0 ... 10 bar
0820048025	-	25 l/min	36 l/min	0 ... 10 bar
0820048102	-	20 l/min	26 l/min	0 ... 8 bar
0820048126	-	20 l/min	26 l/min	0 ... 8 bar

Nominal flow Q_n at 6 bar and $\Delta p = 1$ bar, MO = Manual override

Technical information

The min. control pressure must be adhered to, since otherwise faulty switching and valve failure may result!

The pressure dew point must be at least 15 °C under ambient and medium temperature and may not exceed 3 °C .

The oil content of compressed air must remain constant during the life cycle.

Use only the approved oils from AVENTICS. Further information can be found in the "Technical information" document (available in the MediaCentre).

Technical information

Material

Housing	polyphenylene sulfide Polyamide fiber-glass reinforced
Seals	Acrylonitrile butadiene rubber

Dimensions

Dimensions

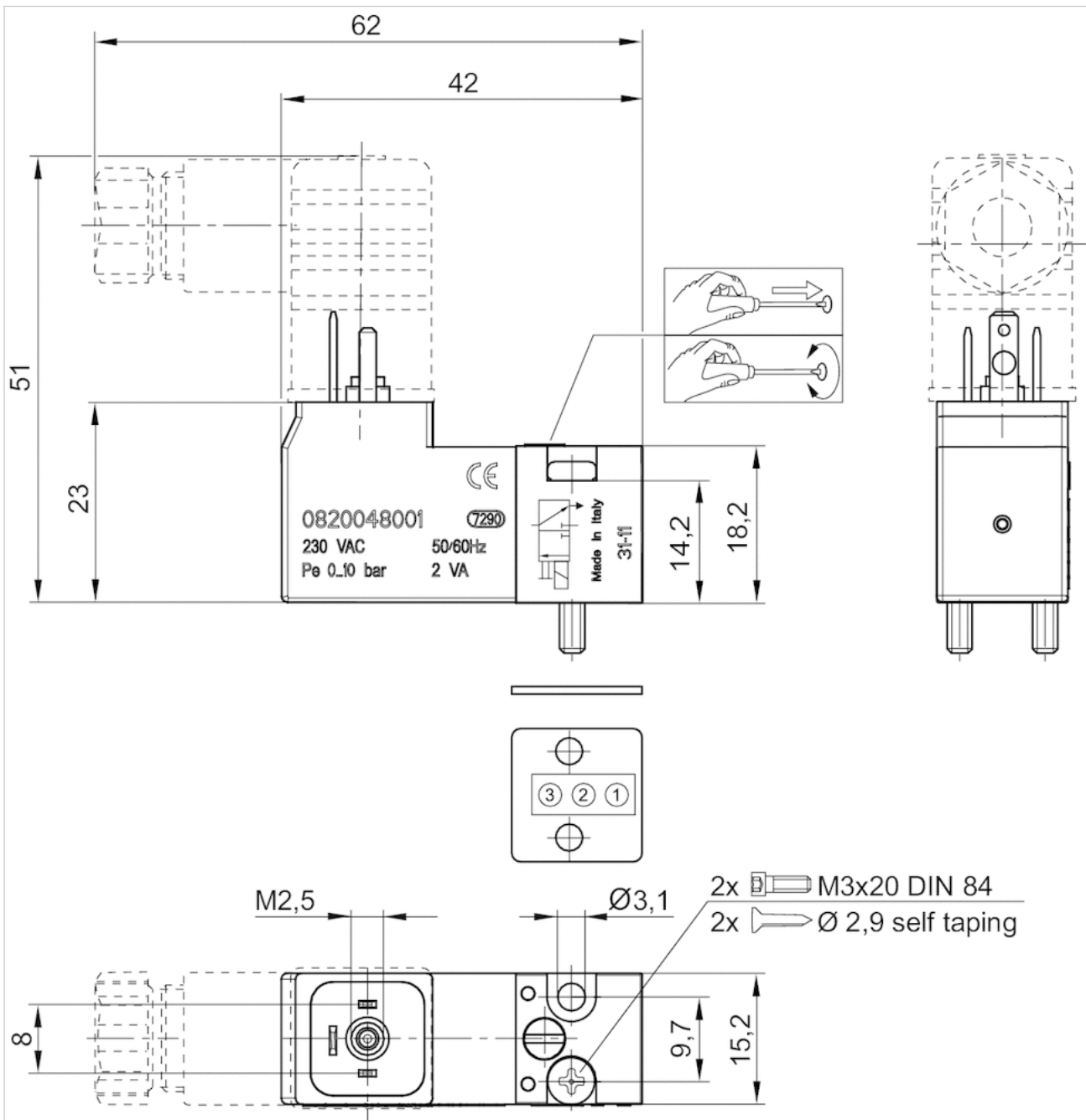

Silencers, series SI1

- G 1/8
- Sintered bronze



Working pressure min./max.	0 ... 10 bar
Ambient temperature min./max.	-25 ... 80 °C
Medium	Compressed air
Sound pressure level	75 dB
Weight	0.01 kg
Comment	Flow characteristic curves can be found under "Diagrams".

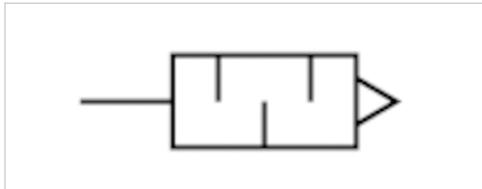

Technical data

Part No.	Compressed air connection	Flow	Delivery unit
		Qn	
1827000000	G 1/8	1623 l/min	10 piece

Weight per piece

Nominal flow Qn at p1 = 6 bar (absolute) freely discharged. Sound pressure level measured at 6 bar against atmosphere at 1 m distance.

Technical information

Material	
Silencer	Sintered bronze
Thread	Brass

Dimensions

Dimensions in mm

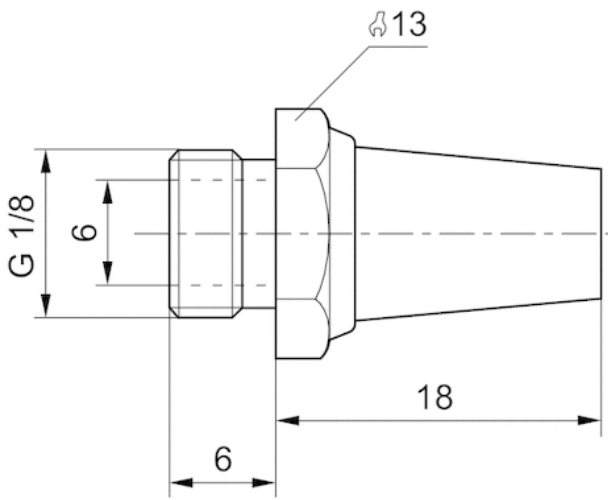

Diagrams

Flow diagram, 1827000000

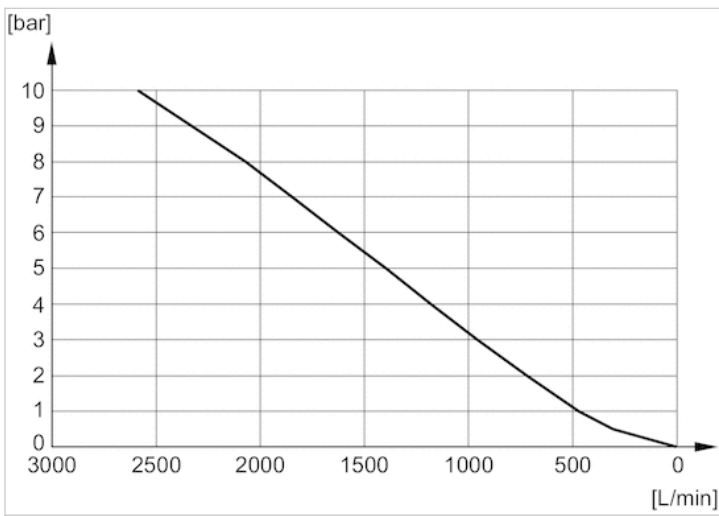

Silencers, series SI1

- G 1/4
- Sintered bronze



Working pressure min./max.	0 ... 10 bar
Ambient temperature min./max.	-25 ... 80 °C
Medium	Compressed air
Sound pressure level	See table below
Weight	See table below
Comment	Flow characteristic curves can be found under "Diagrams".

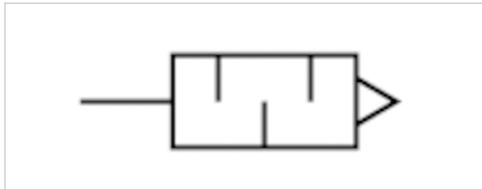

Technical data

Part No.	Compressed air connection	Sound pressure level	Flow	Delivery unit	Weight
			Qn		
R412004817	G 1/4	-	5950 l/min	10 piece	0.013 kg
1827000001	G 1/4	79 dB	3390 l/min	10 piece	0.02 kg

Weight per piece

Nominal flow Qn at p1 = 6 bar (absolute) freely discharged. Sound pressure level measured at 6 bar against atmosphere at 1 m distance.

Technical information

Material	
Silencer	Sintered bronze
Thread	Brass

Dimensions

Dimensions in mm

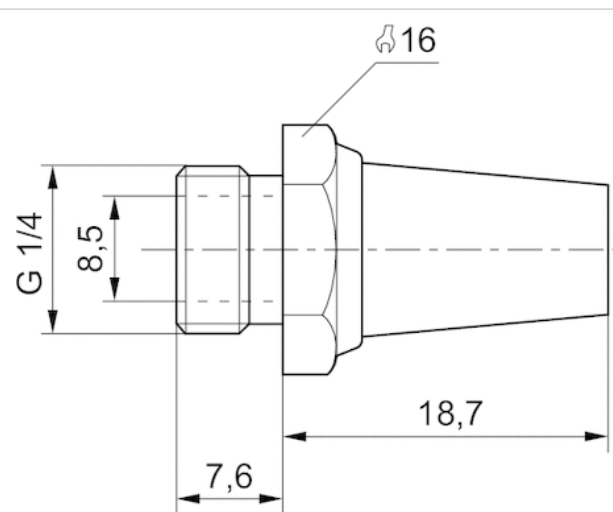

Dimensions in mm

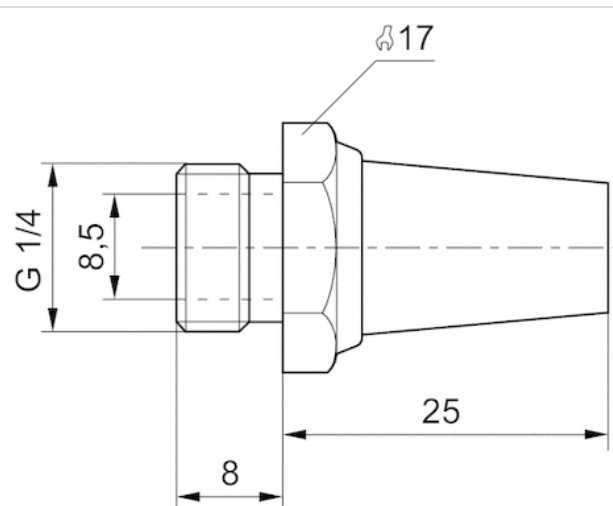

Blanking plate



Working pressure min./max.	-0.9 ... 10 bar
Ambient temperature min./max.	0 ... 80 °C
Medium temperature min./max.	0 ... 80 °C
Medium	Compressed air
Mounting screw	with hexagon socket
Weight	0.02 kg

Technical data

Part No.

1825503932

Scope of delivery incl. mounting screws

Technical information

The min. control pressure must be adhered to, since otherwise faulty switching and valve failure may result!
 The pressure dew point must be at least 15 °C under ambient and medium temperature and may not exceed 3 °C .
 The oil content of compressed air must remain constant during the life cycle.
 Use only the approved oils from AVENTICS. Further information can be found in the "Technical information" document (available in the MediaCentre).

Technical information

Material

Base plate

Aluminum

Dimensions

Dimensions

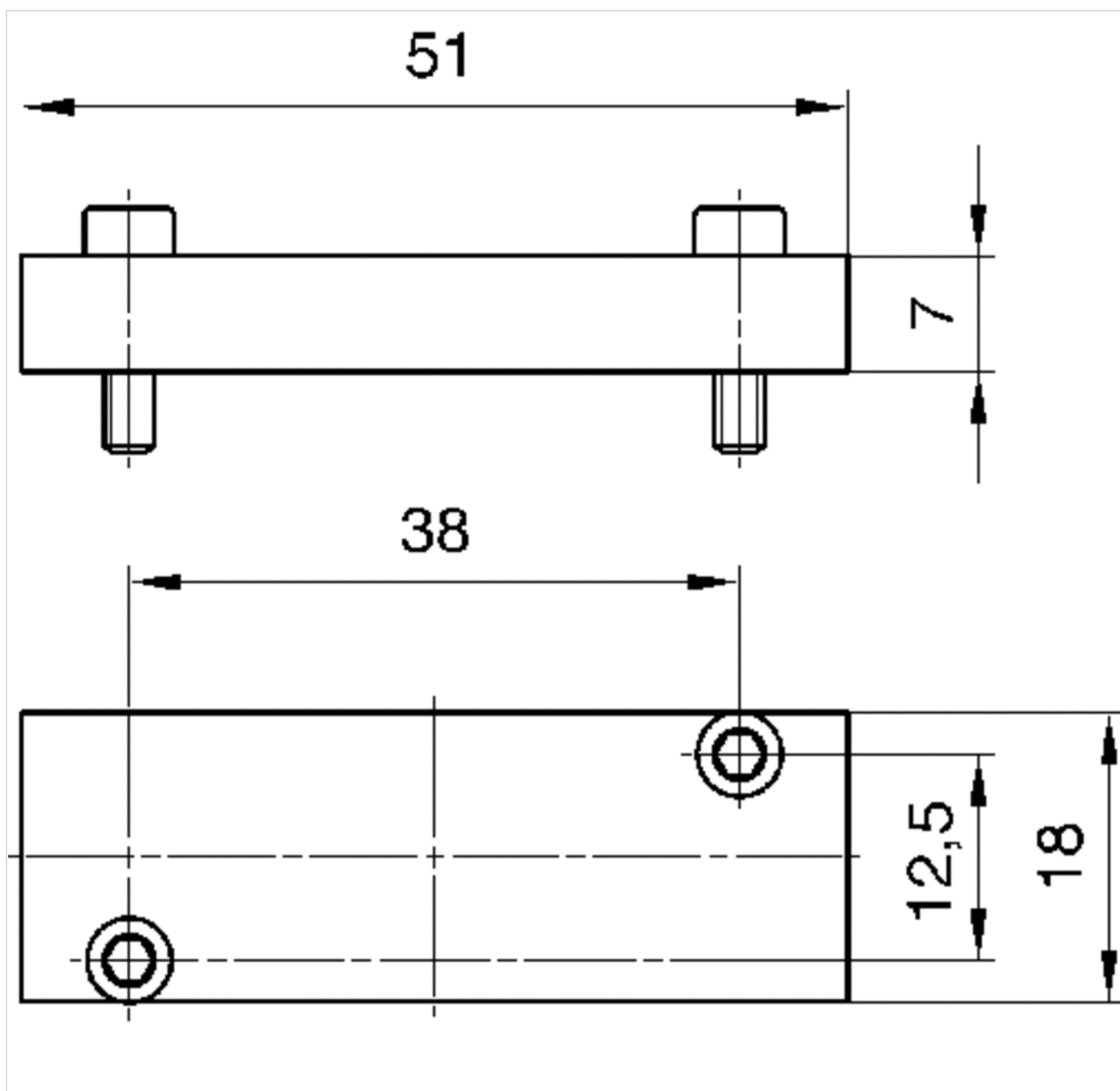

Manifold block

- Single base plate principle



Compressed air connection	according to ISO 228-1
Working pressure min./max.	See table below
Ambient temperature min./max.	See table below
Medium temperature min./max.	See table below
Medium	Compressed air
Direction of pneumatic port (1)	On the side
Direction of pneumatic port (3,5)	On the side
Exhaust type	Ports separated
Mounting screw	with hexagon socket
Weight	See table below

Technical data

Part No.	Compressed air connection	
	Input [1]	Exhaust [3 / 5]
1825503893	G 1/4	G 1/4
1825503894	G 1/4	G 1/4
1825503895	G 1/4	G 1/4
1825503896	G 1/4	G 1/4
1825503897	G 1/4	G 1/4
1825503898	G 1/4	G 1/4
1825503899	G 1/4	G 1/4
1825503900	G 1/4	G 1/4
1825503901	G 1/4	G 1/4

Part No.	Compressed air connection	
	Pilot connection [X]	Pilot control exhaust [R]
1825503893	-	-
1825503894	M5	M5
1825503895	-	-
1825503896	-	-
1825503897	-	-
1825503898	M5	M5
1825503899	-	-
1825503900	-	-
1825503901	-	-

Part No.	Working pressure min./max.	Number of valve positions	Grid dimension
1825503893	0 ... 10 bar	2	-
1825503894	-0.9 ... 10 bar	3	19 mm
1825503895	0 ... 10 bar	4	-
1825503896	0 ... 10 bar	5	-

Part No.	Working pressure min./max.	Number of valve positions	Grid dimension
1825503897	0 ... 10 bar	6	-
1825503898	-0.9 ... 10 bar	7	19 mm
1825503899	0 ... 10 bar	8	-
1825503900	0 ... 10 bar	9	-
1825503901	0 ... 10 bar	10	-

Part No.	Weight
1825503893	0.195 kg
1825503894	0.26 kg
1825503895	0.325 kg
1825503896	0.39 kg
1825503897	0.455 kg
1825503898	0.52 kg
1825503899	0.585 kg
1825503900	0.65 kg
1825503901	0.715 kg

Scope of delivery incl. seal and mounting screws

Technical information

The min. control pressure must be adhered to, since otherwise faulty switching and valve failure may result!

The pressure dew point must be at least 15 °C under ambient and medium temperature and may not exceed 3 °C .

The oil content of compressed air must remain constant during the life cycle.

Use only the approved oils from AVENTICS. Further information can be found in the "Technical information" document (available in the MediaCentre).

Technical information

Material	
Base plate	Aluminum
Seal	Acrylonitrile butadiene rubber

Dimensions

Dimensions

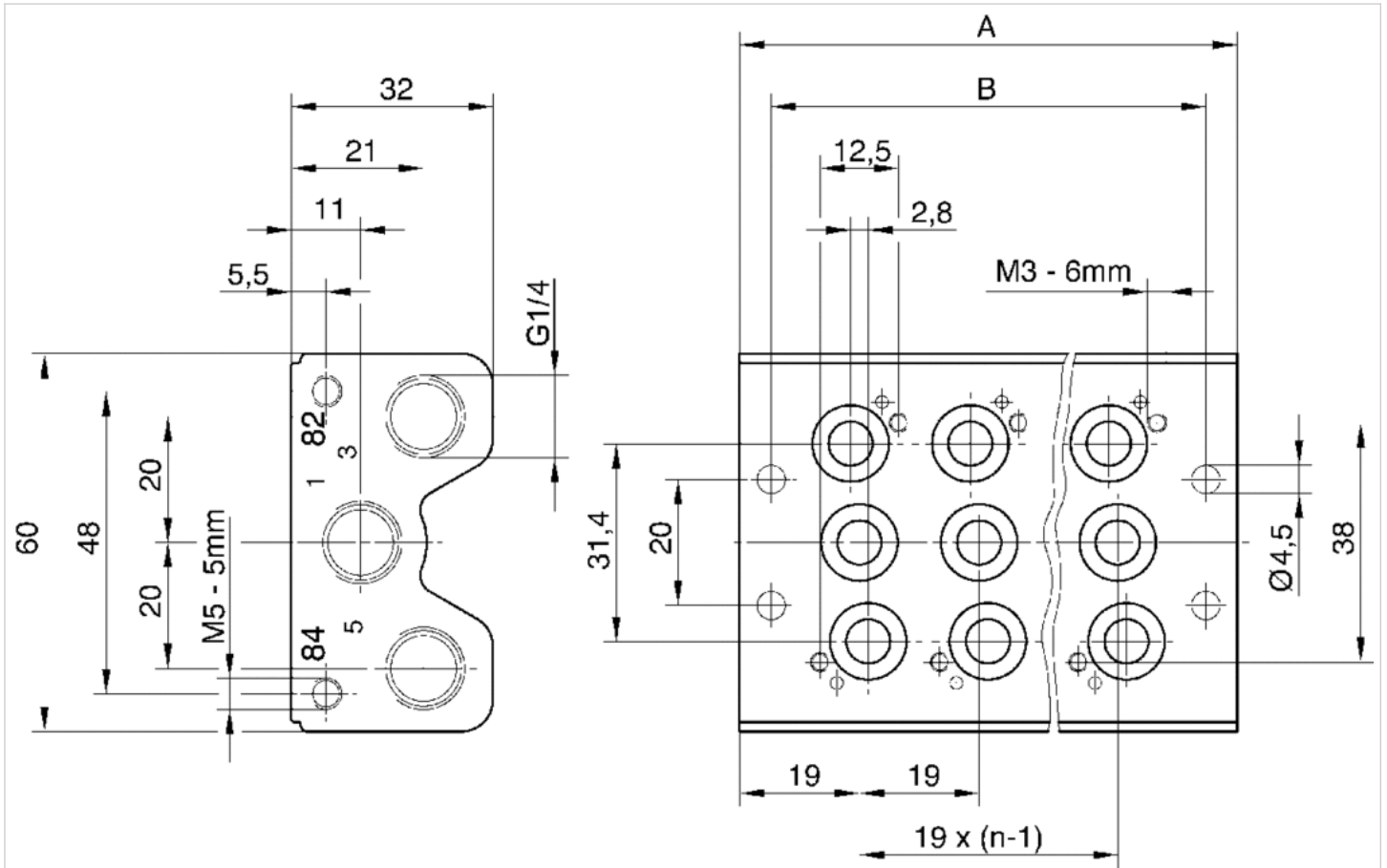

Ports 82 and 84: pilot exhaust air

Dimensions

Part No.	A	B
1825503893	57	47
1825503894	76	66
1825503895	95	85
1825503896	114	104
1825503897	133	123
1825503898	152	142
1825503899	171	161
1825503900	190	180
1825503901	209	199

Efficient pneumatic solutions, our program: cylinders and drives, valves and valve systems, air supply management

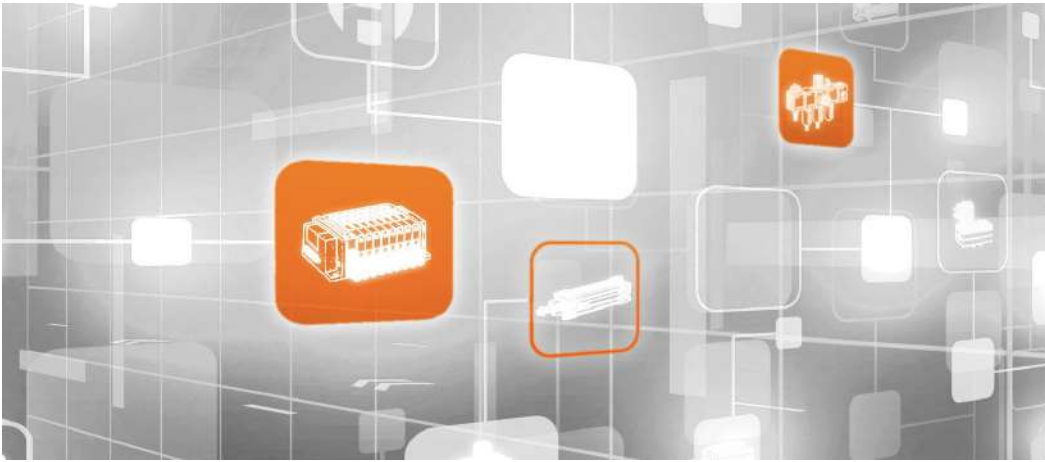

Visit us: Emerson.com/Aventics

Your local contact: Emerson.com/contactus



Emerson.com



[Facebook.com/EmersonAutomationSolutions](https://www.facebook.com/EmersonAutomationSolutions)



[LinkedIn.com/company/Emerson-Automation-Solutions](https://www.linkedin.com/company/Emerson-Automation-Solutions)



[Twitter.com/EMR_Automation](https://twitter.com/EMR_Automation)

An example configuration is depicted on the title page. The delivered product may thus vary from that in the illustration. Subject to change. This Document, as well as the data, specifications and other information set forth in it, are the exclusive property of AVENTICS GmbH. It may not be reproduced or given to third parties without its consent. Only use the AVENTICS products shown in industrial applications. Read the product documentation completely and carefully before using the product. Observe the applicable regulations and laws of the respective country. When integrating the product into applications, note the system manufacturer's specifications for safe use of the product. The data specified only serve to describe the product. No statements concerning a certain condition or suitability for a certain application can be derived from our information. The information given does not release the user from the obligation of own judgment and verification. It must be remembered that the products are subject to a natural process of wear and aging.

The Emerson logo is a trademark and service mark of Emerson Electric Co. Brand logotype are registered trademarks of one of the Emerson family of companies. All other marks are the property of their respective owners. © 2017 Emerson Electric Co. All rights reserved.
2019-03



CONSIDER IT SOLVED™